

# Operating instructions

Under-worktop refrigerator for integrated use, door-on-door

GB

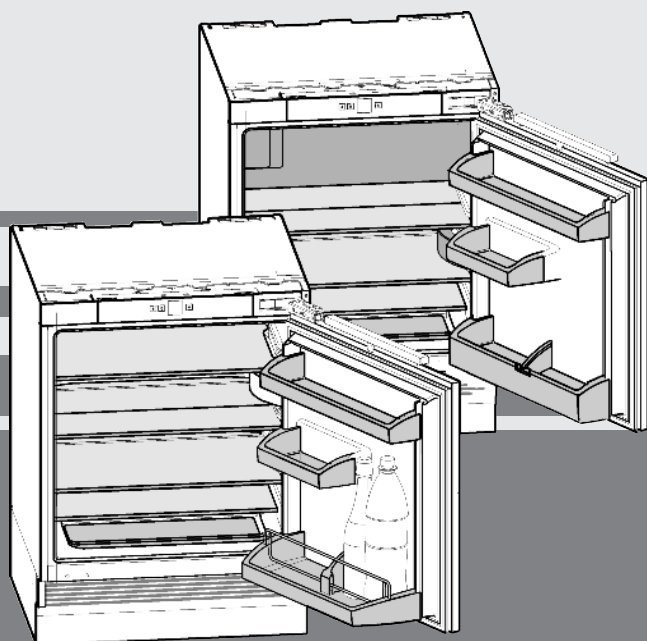

280110 **7084172 - 00**

**UIK1620/ UIK1424 ... 3**

# LIEBHERR

# Appliance at a glance

## Contents

<b>1</b>	<b>Appliance at a glance</b> .....	<b>2</b>
1.1	Description of appliance and equipment.....	2
1.2	Range of appliance use.....	2
1.3	Conformity.....	2
1.4	Saving energy.....	3
<b>2</b>	<b>General safety information</b> .....	<b>3</b>
<b>3</b>	<b>Controls and displays</b> .....	<b>3</b>
3.1	Operating and control elements.....	3
3.2	Temperature display.....	3
<b>4</b>	<b>Putting into operation</b> .....	<b>3</b>
4.1	Transporting the appliance.....	3
4.2	Installing the appliance.....	3
4.3	Disposing of packaging.....	4
4.4	Connecting the appliance.....	4
4.5	Switching on the appliance.....	4
<b>5</b>	<b>Control</b> .....	<b>4</b>
5.1	Refrigerator compartment.....	4
5.2	Freezer compartment.....	5
<b>6</b>	<b>Maintenance</b> .....	<b>5</b>
6.1	Defrosting.....	5
6.2	Cleaning the appliance.....	6
6.3	Replacing the interior light.....	6
6.4	Customer service.....	6
<b>7</b>	<b>Malfunction</b> .....	<b>7</b>
<b>8</b>	<b>Decommissioning</b> .....	<b>7</b>
8.1	Switching off the appliance.....	7
8.2	Taking the appliance out of service.....	7
<b>9</b>	<b>Disposing of the appliance</b> .....	<b>7</b>

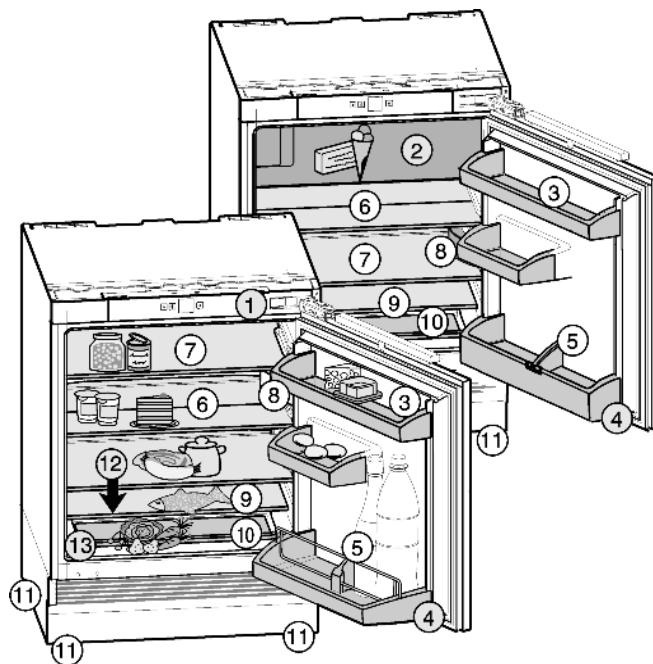

Fig. 1

- |                            |   |
|----------------------------|---|
| (1) Operating panel        | (8) Interior light                          |
| (2) Freezer compartment*   | (9) Coldest zone                            |
| (3) Butter and cheese tray | (10) Vegetable bin                          |
| (4) Bottle rack*           | (11) Height-adjustable feet, front and back |
| (5) Bottle holder*         | (12) Water drain                            |
| (6) Shelf, sectioned       | (13) Type plate                             |
| (7) Shelf, relocatable     |   |

The manufacturer works constantly on the further development of all the types and models. Therefore please understand that we have to reserve the right to make design, equipment and technical modifications.

To get to know all the benefits of your new appliance, please read the information contained in these instructions carefully.

The instructions apply to several models. Differences may occur. Text relating only to specific appliances is marked with an asterisk (\*).

**Instructions for action are marked with a ►, the results of action are marked with a ▷.**

## 1 Appliance at a glance

### 1.1 Description of appliance and equipment

#### Note

- Place food inside the appliance as shown in the diagram. This allows the appliance to save energy during operation.
- Shelves, drawers and baskets are arranged for optimum energy efficiency on delivery.

### 1.2 Range of appliance use

In the case of commercial food cooling, the pertinent statutory regulations have to be observed. The appliance is not suited for storing and cooling pharmaceuticals, blood plasma, laboratory preparations or similar substances and products subject to the Medical Devices Directive 2007/47/EC. Any misuse of the appliance may result in damage to or spoilage of the stored goods. Furthermore, the appliance is unsuited for use in areas exposed to an explosion hazard.

The appliance is suitable for integrated, under-worktop use.

The appliance is set to operate within specific ambient temperature limits according to its climate rating. The correct climate rating for your appliance is indicated on the type plate.

#### Note

- Compliance with the ambient temperatures indicated is required, otherwise the cooling performance is reduced.

Climate rating	for ambient temperatures of
SN	10 °C to 32 °C
N	16 °C to 32 °C
ST	16 °C to 38 °C
T	16 °C to 43 °C

### 1.3 Conformity

The refrigerant circuit has been tested for leaks. When installed, this appliance complies with the relevant safety provisions and EC directives 2006/95/EC and 2004/108/EC.

## 1.4 Saving energy

- Always ensure good ventilation. Do not cover ventilation openings or grille.
- Do not place appliance in areas of direct sunlight or next to a stove, heater or similar object.
- The energy consumption depends on the installation conditions, e.g. the ambient temperature (see 1.2).
- Keep the time the appliance is open to a minimum.
- Store food logically.
- Ensure that all food is well packed and covered for storage. This will prevent frost from forming.
- First cool warm food to room temperature before storing it.
- Defrost frozen food in the refrigerator.\*
- If there is a thick layer of frost in the appliance: defrost the appliance.\*

## 2 General safety information

### Danger for the user:

- This appliance is not designed for persons (including children) with physical, sensory or mental impairment or persons not having sufficient experience and knowledge, unless they are instructed in the use of the appliance and are initially supervised by a person responsible for their safety. Keep children under supervision to ensure they do not play with the appliance.
- In case of a fault, pull out the mains plug (not by pulling the connecting cable) or switch off the fuse.
- Have any repairs to or intervention in the appliance, and any change of the mains power cable, carried out by the customer service only or by other specialised personnel trained for the purpose.
- When disconnecting the appliance from the supply, always take hold of the plug. Do not pull the cable.
- Install and connect the appliance only as instructed.
- Please keep these instructions in a safe place and pass them on to any subsequent owners.

### Fire hazard:

- The refrigerant R 600a is environmentally friendly but flammable. Escaping refrigerant may ignite.
  - Do not damage the refrigerant circuit pipes.
  - Do not allow naked flames or ignition sources to enter the appliance.
  - Do not use any electrical appliances in the interior (e.g. steam cleaners, heaters, ice cream maker etc.).
  - If refrigerant escapes: eliminate naked flames or sources of ignition from the vicinity. Pull out the power plug. Ventilate the area well. Notify customer service.
- Do not store explosives or sprays using combustible propellants such as butane, propane, pentane, etc. in the appliance. Respective spray cans can be identified by reference to the contents printed on the can or by a flame symbol. Gases possibly escaping may ignite due to electrical components.
- Only store high-percentage alcohol in tightly sealed, upright containers. Alcohol possibly escaping may ignite due to electrical components.

### Danger of tipping and falling:

- Do not misuse the plinth, drawers, doors etc. as a step or for support. This applies particularly to children.

### Danger of food poisoning:

- Do not consume food which has been stored too long.

### Danger of frostbite, numbness and pain:

- Avoid lasting skin contact with cold surfaces or refrigerated/frozen food or take protective steps, e.g. wear gloves. Do not consume ice cream, water ice or ice cubes immediately and do not consume them too cold.

Please observe the specific information in the other sections:

	DANGER	identifies a situation involving direct danger which, if not obviated, may result in death or severe bodily injury.
	WARNING	identifies a dangerous situation which, if not obviated, may result in death or severe bodily injury.
	CAUTION	identifies a dangerous situation which, if not obviated, may result in minor or medium bodily injury.
	NOTICE	identifies a dangerous situation which, if not obviated, may result in damage to property.
	Note	identifies useful information and tips.

## 3 Controls and displays

### 3.1 Operating and control elements

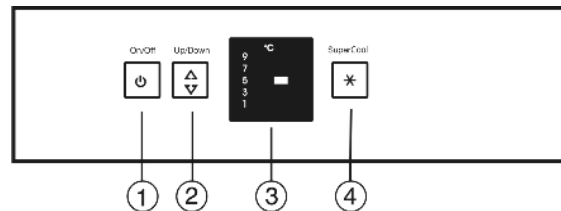

Fig. 2

- (1) On/Off button
- (2) Setting button
- (3) Temperature display
- (4) SuperCool button

### 3.2 Temperature display

The following are displayed in normal operation:

- the set cooling temperature

## 4 Putting into operation

### 4.1 Transporting the appliance



#### CAUTION

Risk of injury and danger of damage as a result of incorrect transport!

- Transport the appliance in a packed condition.
- Transport the appliance upright.
- Do not transport the appliance without assistance.

### 4.2 Installing the appliance

In the event that the appliance is damaged, contact the supplier immediately before connecting to the mains.

The floor at the site must be flat and level.

Do not install the appliance in a location where it is exposed to direct radiation of the sun, next to a cooker, heater and similar.

The appliance is suitable for integrated, under-worktop use.

Do not install the appliance without assistance.

# Control

Standard EN 378 specifies that the room in which you install your appliance must have a volume of 1 m<sup>2</sup> per 8 g of R 600a refrigerant used in the appliance. If the room in which the appliance is installed is too small, a flammable gas-air mixture may form in the event of a leakage in the refrigeration circuit. The quantity of refrigerant used in your appliance is indicated on the type plate on the inside of the appliance.



## WARNING

Fire hazard due to dampness!

If live parts or the mains lead become damp this may cause short circuits.

- ▶ The appliance is designed for use in enclosed areas. Do not operate the appliance outdoors or in areas where it is exposed to splash water or damp conditions.



## WARNING

Fire hazard due to refrigerant!

The refrigerant R 600a is environmentally friendly but flammable. Escaping refrigerant may ignite.

- ▶ Do not damage the piping of the refrigeration circuit.



## WARNING

Fire hazard and danger of damage!

- ▶ Do not place appliances emitting heat e.g. microwaves, toasters etc. on the appliance!

- ▶ Detach the connecting cable from the rear of the appliance, removing the cable holder at the same time because otherwise there will be vibratory noise!

After installation:

- ▶ Remove the protective film from the decorative trims.
- ▶ Remove all transit supports.
- ▶ Dispose of packaging material (see 4.3) .  
For Side-by-Side installation, freezer and refrigerator side by side:
- ▶ Always install the freezer on the right of the refrigerator, as seen from the front.
- ▷ No condensate forms between the appliances thanks to the side wall heating system foamed in on the left.

Ventilation is effected by way of the plinth.

If the appliance is installed in a very damp environment, condensate may form on the outside of the appliance.

- ▶ Always see to good ventilation at the installation site.

## 4.3 Disposing of packaging



## WARNING

Danger of suffocation due to packing material and plastic film!

- ▶ Do not allow children to play with packing material.

The packaging is made of recyclable materials:

- corrugated board/cardboard
- EPS moulded parts
- polythene bags and sheets
- polypropylene straps

- ▶ Take the packaging material to an official collecting point.



## 4.4 Connecting the appliance

### NOTICE

Risk of damage to the electronic control system!

- ▶ Do not use stand-alone inverters (conversion of d.c. to a.c./three-phase) or energy saving plugs.



## WARNING

Fire and overheating hazard!

- ▶ Do not use extension cables or multiple socket outlets.

The type of current (alternating current) and voltage at the installation site have to conform with the data on the type plate (see Appliance at a glance).

Connect the appliance only with a properly installed socket outlet with earthing contact. The socket outlet must be fused with 10 A or higher.



- ▶ Check the electrical connection.
- ▶ Clean the appliance (see 6.2) .
- ▶ Plug in the power plug.

## 4.5 Switching on the appliance

- ▶ Press On/Off button *Fig. 2 (1)*.

▷ The appliance is switched on. The temperature display indicates the set temperature.

# 5 Control

## 5.1 Refrigerator compartment

The natural circulation of air in the refrigerator compartment results in zones differing in temperature. It is coldest directly above the vegetable drawers and at the rear wall. It is warmest at the top front of the compartment and in the door.

### 5.1.1 Food refrigeration

- ▶ Store perishable food such as ready-to-serve dishes, meat products and sausages in the coldest zone. Place butter, eggs and preserves in the upper area and in the door (see Appliance at a glance).
- ▶ Use recyclable plastic, metal, aluminium and glass containers and cling film for wrapping.
- ▶ Do not store food too close together to enable good air circulation.
- ▶ To safeguard bottles from tipping over: move the bottle holder.

### 5.1.2 Setting the temperature

The temperature depends on the following factors:

- the door opening frequency
- the room temperature at the site where the appliance is installed
- the type, temperature and quantity of frozen food

Temperature setting to be recommended: 5 °C

An average temperature of approx. -18 °C is then established in the freezer compartment.

The temperature can be changed continuously. Once the 1 °C setting is reached, it starts again with 9 °C.

- ▶ To access temperature adjustment: press the setting button *Fig. 2 (2)* once.
- ▶ Press the setting button *Fig. 2 (2)* the number of times needed until the required temperature shines in the LED display.

### Note

- ▶ Long pressing of the setting button sets a slightly colder value within a small temperature range (e.g.: between "5" and "7"), but it is not visible in the display.

### 5.1.3 SuperCool

With SuperCool you switch to the highest cooling performance to reach lower cooling temperatures. Use SuperCool, to rapidly cool large amounts of food.

When SuperCool is activated, the fan runs. The appliance operates with maximum refrigeration. The noise of the refrigeration unit may be temporarily louder as a result.

The SuperCool function uses slightly more energy.

### Cooling with SuperCool

- ▶ Briefly press SuperCool button *Fig. 2 (4)*.
- ▷ The SuperCool button *Fig. 2 (4)* lights up.
- ▷ The cooling temperature drops to the coldest value. SuperCool is activated.
- ▷ SuperCool is automatically deactivated after 6 to 12 hours. The appliance continues to operate in the energy-saving, normal mode.

### To prematurely deactivate SuperCool

- ▶ Briefly press SuperCool button *Fig. 2 (4)*.
- ▷ The SuperCool button *Fig. 2 (4)* goes out.
- ▷ SuperCool is deactivated.

### 5.1.4 Relocating the shelves

The shelves have stops preventing them from being unintentionally pulled out.

- ▶ Lift the shelf and draw it out forwards.

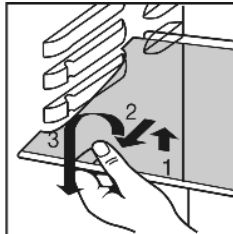

- ▶ Insert shelf with the raised edge pointing upwards at the back.
- ▷ The food does not freeze onto the rear wall.

### 5.1.5 Using the sectioned shelf

- ▶ Slide the sectioned shelf under, as shown in the illustration.

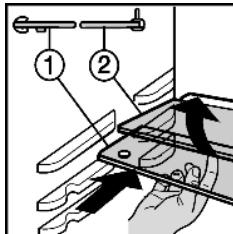

### 5.1.6 Removing the storage rack

- ▶ Remove storage rack according to illustration.

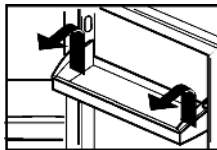

### 5.1.7 Removing the bottle holder

- ▶ Remove the bottle holder according to the illustration.\*

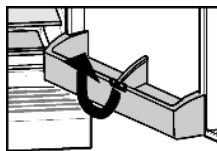
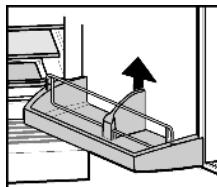

## 5.2 Freezer compartment\*

You can store frozen food for several months, make ice cubes and freeze fresh food in the freezer compartment at a temperature of -18 °C and lower.

The air temperature in the compartment, measured by thermometer or other instruments, may fluctuate.

### 5.2.1 Freezing food\*

2 kg fresh food/24 h is the maximum weight which can be frozen.



#### CAUTION

Risk of injury due to broken glass!

Bottles and cans containing drinks may burst when being frozen. This applies particularly to sparkling drinks.

- ▶ Do not freeze bottles and cans containing drinks!

- ▶ 24 h before freezing food, set the temperature to a medium to cold position.

In order that the food is rapidly frozen through to the core, do not exceed the following quantities per pack:

- Fruit, vegetables up to 1 kg
- Meat up to 2.5 kg
- ▶ Pack the food in portions in freezer bags, reusable plastic, metal or aluminium containers.
- ▶ Set the temperature back again 24 h after placing the food inside.

### 5.2.2 Storage times\*

#### Guide times for storing various types of food in the freezer compartment:

Ice cream	2 to 6 months
Sausage, ham	2 to 6 months
Bread, bakery products	2 to 6 months
Game, pork	6 to 10 months
Fish, fatty	2 to 6 months
Fish, lean	6 to 12 months
Cheese	2 to 6 months
Poultry, beef	6 to 12 months
Vegetables, fruit	6 to 12 months

Storage times given are guide times.

### 5.2.3 Thawing food\*

- in the refrigerator compartment
- at room temperature
- in a microwave oven
- in a conventional or fan oven
- ▶ Food once thawed should be re-frozen only in exceptional cases.

## 6 Maintenance

### 6.1 Defrosting

#### 6.1.1 Defrosting refrigerator compartment

The refrigerator compartment is defrosted automatically. The water evaporates. Drops of water on the rear wall are functionally conditioned and perfectly normal.

- ▶ Clean the drain hole at regular intervals to allow the defrost water to drain (see 6.2).

# Maintenance

## 6.1.2 Defrosting freezer compartment\*

A layer of frost and ice forms in the freezer compartment after the appliance has been in use for a lengthy period of time. This is quite normal. The layer of frost and ice forms more quickly if the door is opened frequently or if the food is warm when placed inside. However, a thick layer of ice will increase the appliance's energy consumption. You should therefore defrost the appliance regularly.



### CAUTION

Risk of injury and damage as a result of hot steam!

- ▶ Do not use electric heaters or steam cleaners, naked flames or defrosting sprays for defrosting.
- ▶ Do not remove ice using sharp instruments.

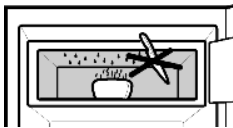
- ▶ Switch off the appliance.
  - ▶ Pull out the plug.
  - ▶ Wrap the frozen food in newspaper or blankets and store in a cool place.
  - ▶ Place a pan with hot, not boiling water on the floor of the compartment.
- 
- ▷ Defrosting is speeded up.
  - ▶ Leave the compartment and appliance door open during defrosting.
  - ▶ Remove detached pieces of ice.
  - ▶ Pay attention that the defrost water does not run into the kitchen unit.
  - ▶ If necessary, pick up defrost water several times, using a sponge or cloth.
  - ▶ Clean the compartment (see 6.2) .

## 6.2 Cleaning the appliance

### Before cleaning:



### CAUTION

Risk of injury and damage as a result of hot steam!  
Hot steam may damage the surfaces and cause burns.

- ▶ Do not use any steam cleaners!

### NOTICE

Incorrect cleaning damages the appliance!

- ▶ Do not use cleaning agents in concentrated form.
- ▶ Do not use any scouring or abrasive sponges or steel wool.
- ▶ Do not use any cleaning agents containing sand, chloride, chemicals or acid.
- ▶ Do not use chemical solvents.
- ▶ Do not damage or remove the type plate on the inside of the appliance. It is important for the customer service.
- ▶ Do not pull off, bend or damage cables or other components.
- ▶ Do not allow any cleaning water to enter the drain channel, ventilation grille or electrical parts.

- ▶ Empty the appliance.
- ▶ Pull out the plug.

- Use soft cleaning cloths and a multi-purpose cleaning agent with neutral pH value.
- Only use food compatible cleaning and care agents on the inside of the appliance.

- ▶ Regularly clean ventilation grilles.
- ▷ Dust deposits increase energy consumption.

### Interior:

- ▶ Clean the plastic surfaces, outside and inside, by hand using lukewarm water and a little washing-up liquid.



- ▶ To clean the drain opening: remove any deposits with a fine instrument, e.g. a cotton bud.

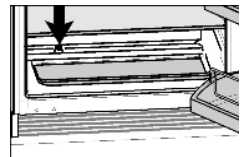

### Items of equipment:

- ▶ Clean items of equipment by hand with lukewarm water and a little washing-up liquid.
- ▶ To dismantle the shelves: remove the trims and side parts.
- ▶ Take apart the door rack as illustrated.

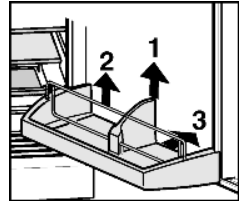

### After cleaning:

- ▶ Wipe dry the appliance and items of equipment.
- ▶ Connect the appliance and switch it on again.
- ▶ Put the food back inside.

## 6.3 Replacing the interior light

### Bulb data

- max. 25 W
- Bulb fitting: E14
- Current type and voltage must conform with the data on the type plate
- ▶ Switch off the appliance.
- ▶ Pull out the mains plug or switch off/unscrew the fuse.
- ▶ Take hold of the lamp cover at the top and bottom *Fig. 3 (1)*.
- ▶ Disengage the lamp cover at the back and detach it *Fig. 3 (2)*.
- ▶ Replace the bulb *Fig. 3 (3)*.
- ▶ Clip the back end of the cover in and clip the sides into place.

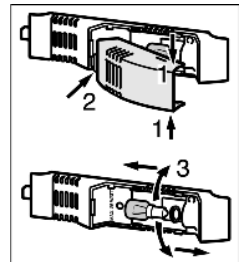

Fig. 3

## 6.4 Customer service

First check whether you can correct the fault yourself by reference to the list (see Malfunction). If this is not the case, please contact the customer service whose address is given in the enclosed customer service list.



### WARNING

Risk of injury if repair work is not carried out professionally!

- ▶ Have any repairs to and intervention in the appliance and mains power cable, which are not expressly mentioned in the (see Maintenance) carried out by the customer service only.

- ▶ Read the appliance designation *Fig. 4 (1)*, service No. *Fig. 4 (2)* and serial No. *Fig. 4 (3)* off the type plate located inside the appliance on the left-hand side.

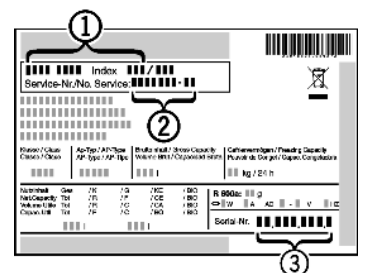

Fig. 4

- ▶ Notify the customer service, specifying the fault, appliance designation *Fig. 4 (1)*, service No. *Fig. 4 (2)* and serial No. *Fig. 4 (3)*.
- ▷ This will help us to provide you with a faster and more accurate service.
- ▶ Keep the appliance closed until the customer service arrives.
- ▷ The food will stay cool longer.
- ▶ Pull out the mains plug (not by pulling the connecting cable) or switch off the fuse.

## 7 Malfunzion

Your appliance is designed and manufactured for a long life span and reliable operation. If a malfunction nonetheless occurs during operation, check whether it is due to a handling error. In this case you will have to be charged for the costs incurred, even during the warranty period. You may be able to rectify the following faults yourself:

### Appliance does not work.

- The appliance is not switched on.
- ▶ Switch on the appliance.
- The power plug is not properly inserted in the wall socket.
- ▶ Check power plug.
- The fuse of the wall socket is not in order.
- ▶ Check fuse.

### The compressor runs for a long time.

- SuperCool is activated.
- ▶ The compressor runs for longer in order to rapidly cool the food. This is normal.

### Excessive noise.

- Speed-controlled\* compressors may produce varying running noise due to different speed steps.
- ▶ The sound is normal.

### A bubbling and gurgling noise.

- This noise comes from the refrigerant flowing in the refrigeration circuit.
- ▶ The sound is normal.

### A quiet clicking noise.

- The noise is produced whenever the refrigeration unit (motor) automatically switches on or off.
- ▶ The sound is normal.

### A hum. It is briefly a little louder when the refrigeration unit (the motor) switches on.

- The refrigeration increases automatically when the SuperCool function is activated, fresh food has just been placed in the appliance or the door has been left open for a while.
- ▶ The sound is normal.
- The ambient temperature is too high.
- ▶ Solution: (see 1.2)

### Vibratory noise.

- The appliance is not standing firmly on the floor. As a result, adjoining units or objects are set into vibration by the running refrigeration unit.
- ▶ Move the appliance away a little and align it using the adjustable feet.
- ▶ Move bottles and containers apart.

### The temperature is not cold enough.

- The door of the appliance is not properly closed.
- ▶ Close the door of the appliance.
- Insufficient ventilation.
- ▶ Clear ventilation grilles.
- The ambient temperature is too high.
- ▶ Solution: (see 1.2)
- The appliance was opened too frequently or for too long.

- ▶ Wait until the appliance reaches the required temperature itself. If not, contact the customer service. (see Maintenance).
- The appliance is too close to a heat source.
- ▶ Solution: (see Putting into operation).

### The interior light is not on.

- The appliance is not switched on.
- ▶ Switch on the appliance.
- The door was open longer than 15 min.
- ▶ The interior light automatically switches off if the door has been open for about 15 min.
- If the interior light is not on but the temperature display is lit, the bulb is faulty.
- ▶ Change the bulb. (see Maintenance).

## 8 Decommissioning

### 8.1 Switching off the appliance

- ▶ Press On/Off button *Fig. 2 (1)* for about 2 seconds.
- ▷ The temperature display is dark.

### 8.2 Taking the appliance out of service

- ▶ Empty the appliance.
- ▶ Pull out the power plug.
- ▶ Clean the appliance (see 6.2).



- ▶ Leave the door open to prevent odour.

## 9 Disposing of the appliance

The appliance contains some reusable materials and should be disposed of properly - not simply with unsorted household refuse. Appliances which are no longer needed must be disposed of in a professional and appropriate way, in accordance with the current local regulations and laws.



When disposing of the appliance, ensure that the refrigeration circuit is not damaged to prevent uncontrolled escape of the refrigerant it contains (data on type plate) and oil.

- ▶ Disable the appliance.
- ▶ Pull out the plug.
- ▶ Cut through the connecting cable.

