

**Gebrauchsanweisung** für Kühl-Gefrier-Kombination, NoFrost

**D**

**Operating instructions** for fridge-freezer combination, NoFrost

**GB**

**Consignes d'utilisation** pour combiné réfrigérateur-congérateur, NoFrost

**F**

**Gebruiksaanwijzing** voor koel-vries-combinatie, NoFrost

**NL**

**Istruzione d'uso** per combinazione frigo-congelatore, NoFrost

**I**

**Instrucciones de manejo** para combinado frigorífico-congelador, NoFrost

**E**

**Instruções de utilização** para o combinado frigorífico-congelador, NoFrost

**P**

**Kullanım Kılavuzu** Soğutucu-Dondurucu-Kombinasyonu, NoFrost

**TR**

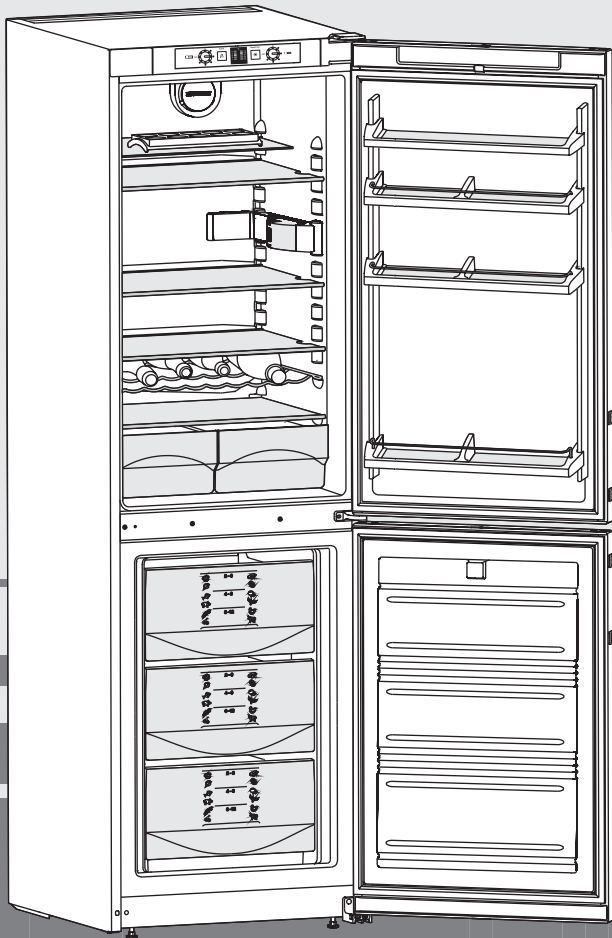

**7081 881-01**

**CN3033**

**4510**

# 1 The appliance at a glance

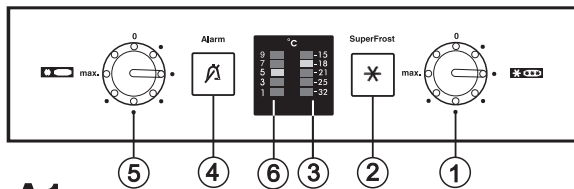

A1

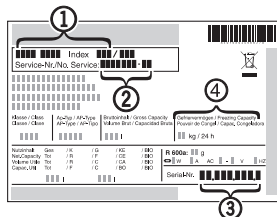
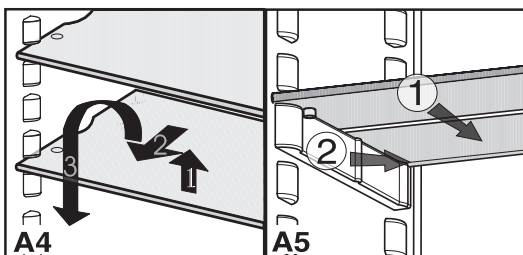
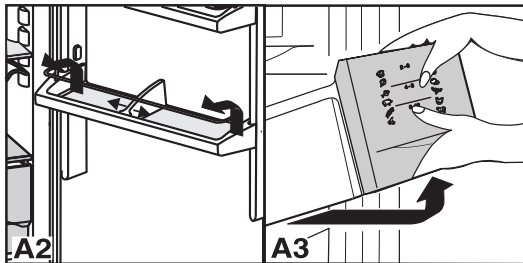

## Operating controls, fig. A1

- ① Main on/off control for the complete appliance (refrigerator and freezer compartment), with temperature control for freezer compartment
- ② SuperFrost button with LED display for activated function - for rapid freezing of fresh food
- ③ Temperature setting display for freezing temperature
- ④ Audible warning on/off button, with LED display for too high temperature in freezer compartment
- ⑤ On/off switch and temperature control for refrigerator compartment
- ⑥ Temperature setting display for refrigerating temperature

## Recommended temperature settings:

- Refrigerator compartment: Temperature setting display ⑥ : 5 °C
- Freezer compartment: Temperature setting display ③ : -18 °C

- By moving the **bottle and can holder**, you can prevent bottles from tipping over when the door is opened and closed. The holder can be removed for cleaning:
  - fig. A2: The holder slides and releases left or right along the door stops.
- You can remove all **door racks** for cleaning, fig. A2: lift rack and pull forwards.
- **The shelves\*** can be adjusted according to height of frozen food, fig. A4.
- Lift the shelf, slide forwards and remove.
- Always insert shelves with the raised edge at the back pointing upwards, otherwise food may freeze onto the rear wall.
- **Removing drawers:** Pull forward until the drawer stops and lift out, fig. A3.
- Fig. A5: If you need space for large bottles and containers, then simply push the front half of glass shelf ① back. For cleaning, the holder ② can be used to remove the half glass shelves.

## Rating plate specifications

- ① Appliance designation
- ② Service number
- ③ Appliance number
- ④ Freezing capacity ... kg/24hrs.

## Description of appliance and equipment, fig. A

### Refrigerator compartment, approx. 5 °C

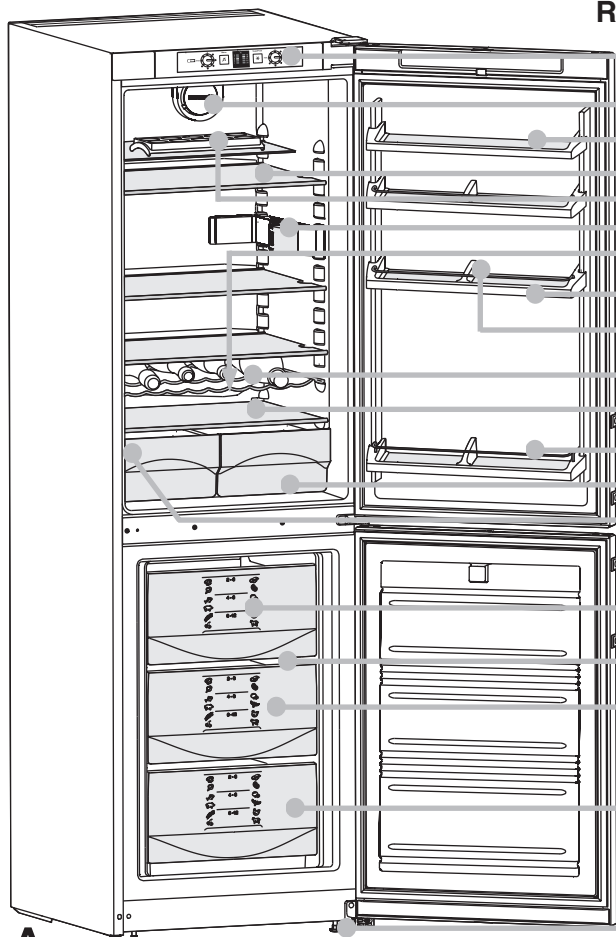

- Operating controls
- Fan with switch ⑦, for increased air circulation
- Butter stop
- Adjustable storage shelves
- Egg tray\*
- Interior light
- Defrost drain
- Adjustable door racks\*
- Adjustable bottle and can holder
- Bottle shelf
- Coldest zone of the refrigerator compartment, for sensitive and perishable foodstuffs
- Door rack for large bottles
- Vegetable, salad and fruit bins
- Rating plate

### Freezer compartment, approx. -18 °C

- Information system\*
- VarioSpace\*
- High drawers
- Ice-cube tray\*
- Adjustable-height feet at front, transport castors at back

A

\* depending on model and options

Congratulations on your purchase. Your appliance offers you all the advantages of modern refrigeration technology, guaranteeing you high quality, a long service life and high reliability.

The features on your appliance have been designed to ensure maximum convenience - day in, day out.

This appliance has been manufactured with recyclable materials using an environmentally friendly process, so together you and we are making an active contribution to the preservation of our environment.

To familiarise yourself with all the advantages your new appliance has to offer, please read the information contained in these operating instructions carefully.

We wish you much pleasure with your new appliance.

<b>Contents</b>	<b>Page</b>
<b>Operating instructions</b>	
<b>1 The appliance at a glance</b> .....	<b>10</b>
Contents .....	11
Information system .....	11
Safety regulations .....	11
Saving energy .....	11
<b>2 Safety instructions and warnings</b> .....	<b>12</b>
Disposal notes .....	12
Technical safety .....	12
Safety during use .....	12
Setting up .....	12
Connecting to the mains .....	12
<b>3 Putting into operation and controls</b> .....	<b>13</b>
Switching the appliance on and off .....	13
Setting the temperature .....	13
Temperature setting display .....	13
Audible warning signal, red visual warning LED .....	13
<b>4 Refrigerator compartment</b> .....	<b>14</b>
Arrangement of food .....	14
Example of food arrangement .....	14
Refrigerating with fan .....	14
Interior light .....	14
<b>5 Freezer compartment</b> .....	<b>15</b>
Making ice-cubes .....	15
SuperFrost .....	15
Notes on freezing and storage .....	15
<b>6 Defrosting, cleaning</b> .....	<b>16</b>
<b>7 Troubleshooting</b> .....	<b>16</b>
Customer service and type plate .....	16
<b>8 Instructions for installation and modification</b>	
Changing over door hinges .....	17
Insertion into row of kitchen units .....	17

Keep these operating instructions in a safe place and pass them on to the next owner, where applicable.  
The operating instructions apply to several models. Differences may therefore occur.

**Safety regulations**

- The device is designed exclusively for the cooling of foodstuffs. The applicable statutory regulations are to be observed in the event that the device is to be used for commercial cooling of foodstuffs. The device is not suitable for the storage and cooling of drugs, blood plasma, laboratory preparations or similar medicine-related materials and products as detailed in the Medical Devices Directive 2007/47/EC. Improper use of the device can cause the stored products stored in it to be damaged or the items can be spoiled. In addition, the device is not suitable for operation in explosion-prone areas.
- The appliance is set to operate within specific ambient temperature limits according to its climate rating. These temperature limits should not be exceeded. The correct climate rating for your appliance is indicated on the type plate. This is explained as follows:

Climate rating	set for ambient temperatures of
SN	+10°C to +32°C
N	+16°C to +32°C
ST	+16°C to +38°C
T	+16°C to +43°C

- The refrigerant circuit has been tested for leaks.
- The appliance complies with current safety regulations and EC directives 2006/95/EC and 2004/108/EC.

**Saving energy**

- Always ensure good ventilation. Do not cover ventilation openings or grille.
- Always keep fan louvres clear.
- Do not place appliance in areas of direct sunlight or next to a stove, heater or similar object.
- The energy consumption depends on the installation conditions, e.g. the ambient temperature.
- Keep the time the appliance is open to a minimum.
- Store food logically.
- Ensure that all food is well packed and covered for storage. This will prevent frost from forming.
- First cool warm food to room temperature before storing it.
- Defrost frozen food in the refrigerator.
- Empty and switch off refrigerating unit for longer vacation periods.

Accumulated dust increases the energy consumption:

- Once a year, dust the refrigerating unit together with the metal grille of the heat exchanger at the back of the appliance.



**Information system\***

Use frozen food within the recommended period. The numbers between the symbols indicate the storage period in months for different kinds of frozen foods. Storage times given are guide times for food frozen at home. Whether or not the lower or upper value is applicable depends on the food quality and how it was processed prior to freezing. The lower values always apply to food with a high fat content.

The symbols have the following signification:

pre-cooked meals		2 - 6	sausages	
ice-cream			bread	
fish		4 - 8	mushrooms	
pork			game	
vegetables		6 - 12	poultry	
fruit			beef/veal	

\* depending on model and options

## 2 Safety instructions and warnings

### Disposal notes

The packaging is made of recyclable materials.

- Corrugated board/board
- EPS moulded parts
- Polythene sheets
- Polypropylene straps

- **Keep packaging materials away from children - polythene sheets and bags can cause suffocation!**
- Please return the packaging to an official collection point.

**Your old appliance:** This contains some reusable materials and should be disposed of properly - not simply with unsorted household refuse.

- Discarded appliances should be disabled: Remove the plug, cut through the connection cable and render the catch unusable so that children cannot become trapped inside.
- Ensure that the refrigerant circuit is not damaged when the appliance that is no longer needed is taken away for disposal.
- Details of the refrigerant can be found on the type plate.
- Appliances which are no longer needed must be disposed of in a professional and appropriate way, in accordance with the current local regulations and laws.

### Technical safety

- To prevent injury or damage to the unit, the appliance should only be transported wrapped and set up by two people.
- The refrigerant R 600a is environmentally friendly but flammable.
- Do not damage the refrigerant circuit pipes. Splashes of refrigerant can harm your eyes or ignite.
- If refrigerant escapes, remove all naked flames or sources of ignition in the vicinity of the leak, disconnect the appliance from the mains and ventilate the area well.
- In the event that the appliance is damaged, contact the supplier immediately before connecting to the mains.
- To guarantee safe operation, ensure that the appliance is set up and connected as described in these operating instructions.
- In the event of a fault, disconnect the appliance from the mains: disconnect mains plug (do not pull on the connection cable) or trigger or unscrew fuse.
- Any repairs and work on the appliance should only be carried out by the customer service department, as unauthorised work could prove highly dangerous for the user. The same applies to changing the mains power cable.

### Safety during use

- Do not store explosives or sprays using combustible propellants such as butane, propane, pentane, etc. in the appliance. Electrical components might cause leaking gas to ignite. You can identify such sprays by the printed contents or a flame symbol.
- Only store high-percentage alcohol in tightly sealed, upright containers.
- Do not allow naked flames or ignition sources to enter the appliance.
- Do not use electrical appliances inside the appliance (e.g. steam cleaners, heaters, ice makers, etc.).
- Do not stand on the plinth, drawers or doors or use them to support anything else.
- This appliance is not intended for use by persons (including children) with reduced physical, sensory or mental capabilities or lack of experience and knowledge unless they have been given initial supervision or instruction concerning use of the appliance by a person responsible for their safety. Children should be supervised to ensure that they do not play with the appliance.
- Avoid prolonged skin contact with cold surfaces or chilled/frozen food. This could cause pain, numbness and frostbite. In the case of prolonged skin contact, protective measures should be taken, e.g. gloves should be worn.
- Do not consume food which has been stored for too long, as it could cause food poisoning.
- Special-purpose lamps (incandescent lamps, LEDs, fluorescent tubes) in the appliance serve to illuminate the appliance interior and are not suited for room illumination.



### Setting up

- When setting up/fitting ensure that the refrigerant circuit pipes are not damaged.
- Once in position, use a 10 spanner to adjust the feet so that the appliance is level and does not wobble.
- Standard EN 378 specifies that the room in which you install your appliance must have a volume of 1 m<sup>3</sup> per 8 g of R 600a refrigerant used in the appliance, so as to avoid the formation of inflammable gas/air mixtures in the room where the appliance is located in the event of a leak in the refrigerant circuit. The quantity of refrigerant used in your appliance is indicated on the type plate on the inside of the appliance.
- Always position the appliance directly up against the wall.
- **The ventilation grilles should not be obstructed.** Please note the appendix concerning installation instructions.
- Condensation may form on the outside of the refrigerator/freezer during periods of high humidity. Constant ventilation of the installation site is recommended.
- Do not place heat-emitting appliances, e.g. microwave oven, toaster, etc., on top of the refrigerator or freezer.
- In order to avoid the risk of fire, do not place any burning candles, lamps or other objects with open flames on the refrigerator/freezer.
- Fire hazard due to dampness!  
If live parts or the mains lead become damp this may cause short circuits.
- The appliance is designed for use in enclosed areas. Do not operate the appliance outdoors or in areas where it is exposed to splash water or damp conditions.
- CAUTION! Risk of injury and danger of damage as a result of incorrect transport!
  - Transport the appliance in a packed condition.
  - Transport the appliance upright.
  - Do not transport the appliance without assistance.
- The appliance may be moved only when it is empty.

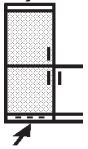

### Connecting to the mains

#### Power supply (AC) and voltage

at the operating point must comply with the details on the rating plate, which is located on the inside left of the appliance, next to the vegetable bins.

- **Connect the appliance with a properly earthed fused plug and socket only.**
- The socket must be fused with a 10 A fuse or higher, it must be away from the rear of the appliance and must be easily accessible.
- Do not connect the appliance to the supply with other equipment using a distribution outlet - risk of overheating.
- When removing the mains cable from the back of the appliance, remove the  **cable holder** as well so as to avoid vibration noise.



The wires in the mains lead are coloured in accordance with the following code:  
green/yellow = earth,  
blue = neutral,  
brown = live.

**Warning! This appliance must be earthed.**

#### Non-rewireable plugs BS 1363

If this machine or appliance is fitted with a non-rewireable plug, the following information applies: If the socket outlets are not suitable for the plug supplied with this product, it must be cut off and an appropriate plug fitted. The plug cut from the flexible cord should be disposed of and on no account be inserted into a 13 A socket elsewhere in the house (electric shock hazard). The fuse cover **must** be re-fitted when changing the fuse, and if the fuse cover is lost the plug **must not** be used until a suitable replacement is obtained. The colour of the correct replacement cover is that of the coloured insert in the base of the plug, or the colour that is embossed in words on the base of the plug (as applicable to the design of the plug fitted). The correct rating of the replacement fuses that are ASTA approved to BS 1362 should be fitted. Replacement fuse covers may be purchased from your local electrical suppliers, electricity showroom or approved service agent.

### 3 Putting into operation and controls

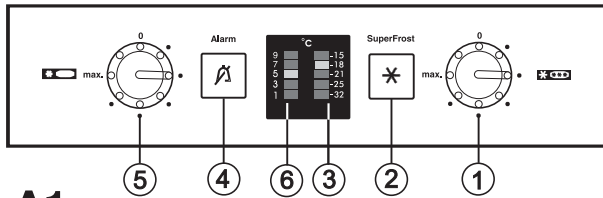

**A1**

You are advised to clean the appliance before switching it on for the first time (see "Cleaning"). Put the appliance into operation approximately 4 hours before loading with frozen food for the first time. Only insert frozen food when the freezer compartment is cold.

#### Switching the appliance on and off

- Fig. A1: With the main On/Off control ① you always switch the complete appliance on or off, freezer and refrigerator compartment.
- **Switching on:** Turn On/Off controls ① and ⑤ with a coin, so that the temperature setting displays ③ and ⑥ flash/light up.
  - The refrigerator compartment is switched on when the temperature setting display ⑥ is lit and the inside lamp is on.
  - The freezer compartment is switched on when the temperature setting display ③ is lit.
  - When operating for the first time the warning LED lights up and the audible alarm is turned off. For more information, see section "Audible warning signal, red visual warning LED".
- **Switching off the complete appliance:** Turn the slot of the main On/Off control ① with a coin right back to position "0", so that the temperature setting displays are unlit. The refrigerator and freezer compartment are switched off.
- If you want to switch off only the **refrigerator compartment**, turn only the On/Off control ⑤ back to "0", so that the temperature setting display of the refrigerator compartment ⑥ and the inside lamp are unlit. The temperature setting display of the freezer compartment ③ must be lit.

#### Setting the temperature

- Fig. A1: Turn temperature controls ① and ⑤ with a coin until the LEDs ③ and ⑥ of the required temperatures are lit. The positions of the slot mean:
 

<b>1<sup>st</sup> dot</b>	= <b>warmest temperature,</b>	
		lowest refrigerating capacity
<b>max.</b>	= <b>coldest temperature,</b>	
		highest refrigerating capacity

- **Recommended temperature setting:**

- For the **refrigerator compartment:** 5 °C
- For the **freezer compartment:** -18 °C

During setting, the LED of the set temperature flashes.

**NB:** Please note that the temperature inside the appliance is affected by the frequency with which the door is opened, how full the appliance is and the room temperature at the place where the appliance is installed. The control is to be readjusted according to the temperature required.

#### Temperature setting display, Fig. A1/③ ⑥

- The illuminated temperature setting display indicates operation of the appliance.
- Temperature ranges are allocated to the individual LEDs. They indicate the selected setting of the refrigerating/freezing temperature.

#### Audible warning signal, red visual warning LED

Fig. A1/④ : The audible warning signal and the red visual warning LED help you to protect the frozen food and to save energy.

- **The buzzer is switched off** by pressing the audible warning on/off button ④ ,
  - and automatically when the sufficiently low storage temperature has been reached again or
  - when the door is closed.

#### Door alarm

- This always sounds when the refrigerator or freezer door is open for more than approx. 60 sec. The sound shut-off is active as long as the door is open. When the door is closed, the alarm function is automatically activated again.

#### Temperature alarm

- This always sounds when the freezing temperature is not cold enough (depending on the temperature setting).
- At the same time *the red visual warning LED flashes.*

Possible causes are:

- warm fresh food was inserted for freezing,
- when rearranging and removing frozen food, too much warm air entered.

The red visual warning LED *continues to flash* until the alarm state is ended.

\* depending on model and options

## 4 Refrigerator compartment

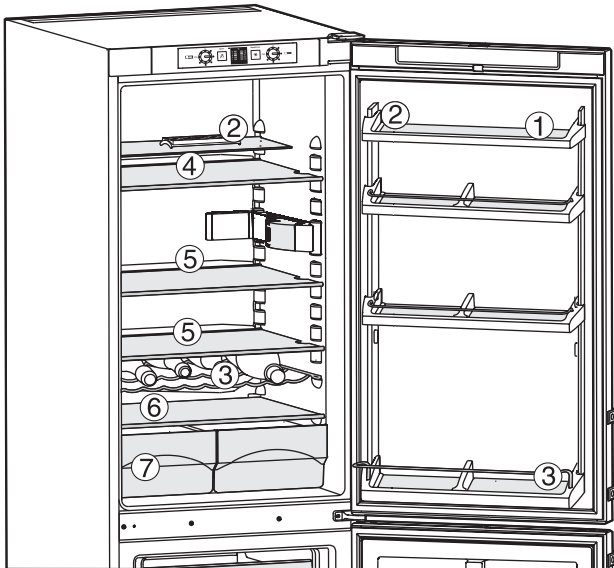

**B**

### Example of food arrangement Fig. B

- 1 butter, cheese
- 2 eggs
- 3 cans, drinks, bottles
- 4 preserves, baked goods
- 5 dairy products
- 6 coldest zone of refrigerator compartment:  
sensitive foods, meat/sausages, fish, raw milk products,  
convenience foods
- 7 fruit, vegetables, salad

### Note

- Place food inside the appliance as shown in the diagram. This allows the appliance to save energy during operation.
- Shelves, drawers and baskets are arranged for optimum energy efficiency on delivery.

### Arrangement of food

Due to the natural air circulation in the refrigerator compartment, different temperature ranges result, which are beneficial for the storage of different foods. Just above the vegetable bins and at the back of the refrigerator, the air is colder, ideal for raw meat or cold meats; at the top front of the compartment and in the door, the air is warmer, making it ideal for cheese and for spreadable butter.

### Notes on refrigerating

- Store food so that the air can circulate freely; do not place items too close together. *Do not cover the ventilator air slots\* on the rear wall* - important for refrigerating capacity!
- Always keep foods which easily give off or take on odours or flavours, and liquids, in closed containers or covered.
- Always store food which gives off or is sensitive to ethylene gases such as fruit, vegetables and salads separately or wrapped in order not to affect their storage life; e.g. do not store tomatoes together with kiwis or cabbage.

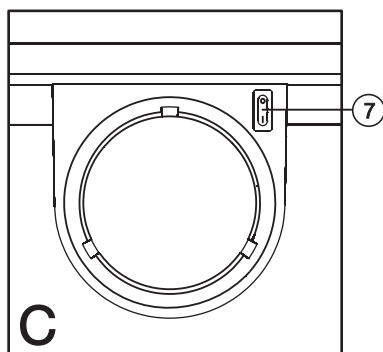

**C**

### Refrigerating with fan\*, fig. C/⑦

This achieves a relatively even temperature distribution over at all storage levels; all foods are equally cool, at an adjustable temperature. Due to the enforced air circulation, the various temperature ranges of normal operation are raised.

It is generally recommended:

- with high room temperature (above approx. 30 °C),
- with high humidity, e.g. on summer days.

### ● Switching on/off: Press fan switch ⑦.

I = on, 0 = off.

### Note:

- When fan is switched on, power consumption is increased.
- To save energy, the fan switches off automatically when the door is open.

### The interior light

switches off automatically when door is open for more than approx. 15 minutes. If the lamp does not light up when the door is opened briefly, but the temperature setting display does, the light bulb may be defective.

### Replacing the bulb:

- **Light-bulb specifications:** max. 25 W, power supply and voltage should match the details on the rating plate. Only use light bulbs with the same dimensions, fitting: E 14.
- Switch off the appliance. **Disconnect mains plug or trip or unscrew fuse.**
- Push the sides 1 of the lamp cover together according to Fig. F1, unlatch and detach 2.
- Replace the light bulb according to Fig. F2. When inserting the new bulb, make sure the seal is correctly positioned in the socket.
- Attach the cover at the rear again and lock into place on sides.

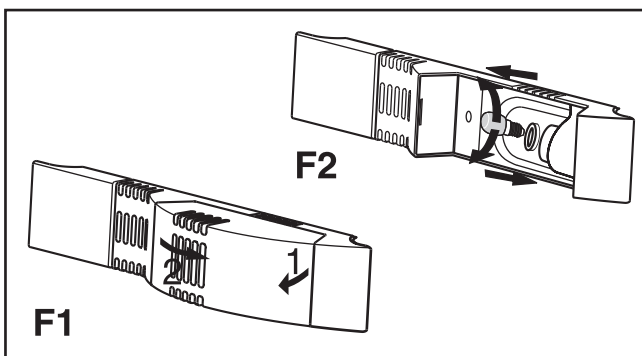

# 5 Freezer compartment

## Making ice-cubes

- Fill the **ice-cube tray\*** three-quarters full with water and freeze. The ice-cubes can be removed from the tray by twisting or by holding upside down for a short time under running water.

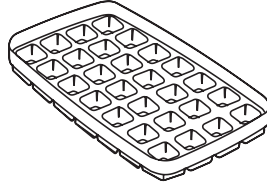

## SuperFrost

The *fresh* foods should be frozen to the core as quickly as possible and frozen foods already stored be given a "cold reserve". This is enabled by the SuperFrost system. This is the best way of maintaining the nutritional value, appearance and flavour of frozen foods.

- The maximum amount of fresh food which can be frozen in 24 hours is shown on the rating plate ("Freezing capacity ... kg/24h"), pos. ④ . The maximum quantity of frozen food varies according to model and climatic class.

## Freezing with SuperFrost

Fig. A1/②

SuperFrost



- Press SuperFrost button ② briefly, so that the LED lights up.
  - The freezing temperature decreases, the appliance works with the greatest possible freezing capacity, at the same time the -32 °C-LED lights up.
- With a smaller amount of food to be frozen, wait/pre-freeze for approx 6 hours - normally sufficient, with the *maximum* quantity, see freezing capacity on rating plate, approx. 24 hours.
- Then insert the fresh food, preferably in the upper bins.
  - **switches off automatically** after approx. 65 hours. The freezing process is complete,
  - the **SuperFrost-** and the **-32°C-LED are unlit**, the appliance works again in energy-saving normal mode of the last temperature setting.
- In order to reach the maximum freezer performance, warm food must be placed directly on the shelves, not in the drawers, or stored in direct contact to the inner side walls.

**Note:** You do *not* have to switch SuperFrost on:

- when inserting already frozen foods,
- when freezing up to approx. 2 kg of fresh food daily.

## Notes on freezing and storage

- As a guideline for the storage time, the following applies to various foodstuffs in the freezer compartment:

Ice cream	2 to 6 months
Sausage, ham	2 to 6 months
Bread, cakes and pastries	2 to 6 months
Game, pork	6 to 10 months
Fish, oily	2 to 6 months
Fish, lean	6 to 12 months
Cheese	2 to 6 months
Poultry, beef	6 to 12 months
Vegetables, fruit	6 to 12 months

- **Suitable packing materials** are conventional freezer bags, reusable plastic, metal and aluminium containers.
- Do not allow fresh food to be frozen to come into contact with food already frozen. Always insert packaging in a dry condition to avoid packaging freezing together.

- Always provide packaging with date and contents and do not exceed the recommended storage time of the frozen food, in order to prevent reductions in quality.

- Always package food which you freeze yourself in suitable portions for your household. So that the food freezes quickly through to the core, the following quantities per package should not be exceeded:

- Fruit and vegetables up to 1 kg,
- meat up to 2.5 kg.

- After washing and portioning, blanch **vegetables** (immerse in boiling water for 2-3 minutes, then remove and cool in cold water). If blanching with a steamer or microwave, observe the relevant instructions).

- Do not salt or season food and blanched vegetables before freezing. Only lightly salt and season other foods. The intensity of flavour of certain seasonings changes.

- Do not freeze bottles and tins containing carbonated beverages, as otherwise they may burst.

- **For storage:** The individual storage tray can support max. 25 kg of frozen goods.

- **VarioSpace:** By removing the 2nd and 3rd draw and the storage tray, you obtain the storage space for bulky goods equivalent to two drawer heights. Poultry, meat, large game pieces and tall baked goods can be frozen whole and further prepared in one piece.

- If you wish to use the max. holding capacity, you can remove the drawers and store the frozen goods directly on the storage trays .

- Only the bottom draw must *always* be left in the appliance.

- When the top drawer is removed, do *not* cover the fan air slots on the back. This is important for proper functioning!

- **Removing drawers, fig. G1:** pull out to stop position and lift up at front.

- **Removing storage tray, fig. G2:** remove 2nd and 3rd drawer, lift storage tray up at front and pull out.

- To insert: simply push storage tray in, snap into position at front.

- **For defrosting,** always only remove as much as will be needed immediately. Defrosted food should be used to prepare

- a meal as soon as possible.

You can defrost frozen food:

- in the oven/fan-assisted oven

- in the microwave

- at room temperature

- Defrosted flat meat and fish portions can be heated up.

- Vegetables can be prepared in a frozen state (at half cooking time as fresh vegetables).

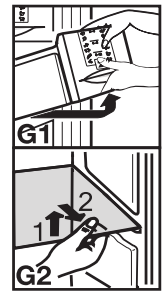

## 6 Defrosting, cleaning

### Defrosting

The NoFrost system defrosts the appliance **automatically**.

#### In the refrigerator compartment

The defrost water is evaporated by the heat from the compressor; drops of water on the rear wall are perfectly normal.

- Ensure that the defrost water can flow freely through the drain hole in the rear wall (arrow in fig. A).

#### In the freezer compartment

The moisture produced accumulates on the evaporator, is periodically defrosted and evaporates.

Due to the automatic defrosting principle, the freezing compartment remains free of ice at all times, no work or time is required for manual defrosting.

### Cleaning

- **Before cleaning, always switch off the appliance. Disconnect from the mains or un-screw or switch off the fuse.**



- Wash shelves, glass plates and other options by hand.
- Clean the outer walls, inside and equipment by hand with lukewarm water and a little detergent. Because of the risk of injury and damage to the appliance, steam cleaning equipment should not be used.
- Do not use abrasive sponges or scourers, do not use concentrated cleaning agents and never use cleaning agents containing sand, chloride or acid or chemical solvents, as these would damage the surfaces and could cause corrosion.
- We recommend using a soft cloth and an all-purpose cleaner with a neutral pH value. Only use food safe cleaning materials inside the appliance.

#### For stainless-steel appliances\*:

- Clean the side panels and door surfaces with a clean and soft cloth. If necessary, use a moist cloth (water + detergent). Alternatively, use a micro-fibre cloth.
- Ensure that no cleaning water penetrates into the electrical components, drain gully\* or ventilation grilles. Wipe the appliance dry.
- Do not damage or remove the type plate on the inside of the appliance. It is very important for servicing purposes.

- Clean the **drain hole** on the rear wall above the vegetable bins regularly, fig. A, arrow.

**If necessary, clean with a thin object, e.g. a cotton swab or similar.**

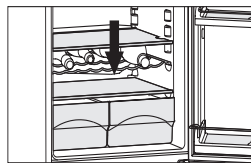

- Ensure that none of the wires or other components are dislodged, bent or damaged.
- Then connect/switch on the appliance.

If the appliance is to be **left switched off for any length of time**, empty the appliance, disconnect from the mains, clean as described above and leave the door open so as to avoid odours.

## 7 Troubleshooting

Your appliance is designed and manufactured in such a way as to provide fault-free operation and a long service life. Nevertheless, if a fault should occur during operation, please check whether the fault is due to incorrect operation. In this case we have to charge you for any costs incurred also within the warranty period.

You can eliminate the following faults yourself by checking the possible causes:

### Fault possible cause and remedy

#### Appliance not working, display is unlit

- Is the appliance switched on properly?
- Is the mains plug properly inserted in the socket?
- Is the socket fuse intact?

#### The interior light does not come on

- Is the refrigerator compartment switched on?
- Was the door open for longer than 15 min.?
- The bulb is defective. Change the bulb as described in "Interior light".

#### Loud running noise

- Is the appliance standing firmly on the floor, or does the compressor cause nearby items of furniture or objects to vibrate?

If necessary, move the appliance slightly, align by adjusting the adjustable feet, or move bottles and containers apart.

- The following are normal:

*Flow noises*, bubbling or dripping, coming from the coolant in the refrigerating circuit.

A soft *clicking sound*, this always occurs when the refrigeration unit (the motor) switches on or off automatically.

*Motor noise*; this will be slightly louder for a brief period when the refrigeration unit switches on. When SuperFrost is switched on, fresh food is inserted, or when the door is open for a long time, the refrigerating capacity increases automatically. A deep humming sound occurs due to *air flow noises of the fan*.

#### Alarm sounds, red visual warning LED flashes, temperature is not low enough

- Were too large quantities of fresh food inserted *without* SuperFrost? (see section "SuperFrost")
- Does the door close properly?
- Is the appliance sufficiently well ventilated? Clear ventilation grilles if necessary.
- Is the ambient temperature too hot? (See "Safety regulations")
- Has the appliance been opened too often or left open too long?
- If applicable, wait until the appliance reaches the required temperature itself.

### Customer service and type plate

If none of the above causes applies and you cannot eliminate the fault yourself or if *more than one* LED is *flashing*, please contact your nearest after-sales service point (see list attached).

Please state the **appliance designation** ①, **service number** ②, **appliance number** ③ of the rating plate (see fig.), and **which LED displays** are flashing so as to ensure rapid, accurate servicing.

The rating plate is located inside the appliance on the left-hand side.

Keep the appliance closed until the after-sales service technician arrives in order to prevent further loss of refrigeration.

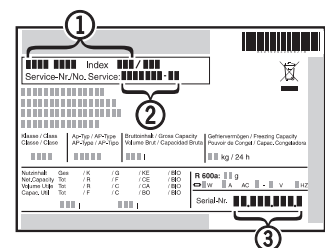

## 8 Instructions for installation and modification

---

Before reading, please fold out the reference page with the illustrations at the back.

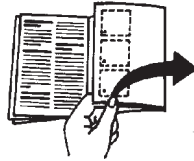

The **external dimensions** of the appliance can be seen on fig. **S**.

Do not install the appliance side-by-side with another refrigerator or freezer. This is important to prevent condensation and consequential damage from it.

### Changing over door hinges

Fig. **T**: You can change over the door hinges if necessary. Follow the order of the positions illustrated in fig. **T/T1**.

### Insertion into row of kitchen units

Fig. **U**: The appliances can be installed in a row of kitchen units. To adapt the height of the appliance to the surrounding furniture a top unit ① can be added.

A gap of at least 50 mm depth must be provided behind and along the entire width of this unit so as to ensure sufficient ventilation. The area of ventilation underneath the ceiling should be at least 300 cm<sup>2</sup>. The greater the area the more economically the appliance will run.

- When setting up the appliance next to a wall ④, a minimum distance of 30 mm must be provided on the hinge side between the appliance and the wall.

- |                           |                        |
|---------------------------|------------------------|
| ① top unit                | ② refrigerator/freezer |
| ③ kitchen unit side panel | ④ wall                 |

