

7081 177-01

CBN 5167 310

LIEBHERR

Disposal notes

The appliance contains some reusable materials and should be disposed of properly - not simply with unsorted household refuse. Appliances which are no longer needed must be disposed of in a professional and appropriate way, in accordance with the current local regulations and laws.



When disposing of the appliance, ensure that the refrigeration circuit is not damaged to prevent uncontrolled escape of the refrigerant it contains (data on type plate) and oil.

- Disable the appliance.
- Pull out the plug.
- Cut through the connecting cable.

! WARNING

Danger of suffocation due to packing material and plastic film! Do not allow children to play with packing material. Take the packing material to an official collecting point.

Range of appliance use

The appliance is suitable solely for cooling food in a domestic environment or similar. This includes use in, for example

- in staff kitchenettes, bed and breakfast establishments,
- by guests in country homes, hotels, motels and other forms of accommodation,
- in catering and similar services in the wholesale trade.

Use the appliance solely as is customary within a domestic environment. All other types of use are inadmissible. The appliance is not suitable for storing and cooling medicines, blood plasma, laboratory preparations or similar substances and products covered by the 2007/47/EC Medical Devices Directive. Misuse of the appliance can result in the stored products suffering harm or perishing. Furthermore, the appliance is not suitable for operation in potentially explosive atmospheres.

Setting up

- Avoid positioning the appliance in direct sunlight or near cookers, radiators and similar sources of heat.
- The floor on which the appliance stands should be horizontal and level. To compensate for any unevenness, adjust the height of the feet with the open-ended spanner supplied.
- The ventilation grilles should not be obstructed. Always ensure that there is good ventilation and that the outward flowing air is able to escape.
- Do not place heat-emitting appliances, e.g. microwave oven, toaster, etc., on top of the appliance.
- Standard EN 378 specifies that the room in which you install your appliance must have a volume of 1 m³ per 8 g of R 600a refrigerant used in the appliance, so as to avoid the formation of inflammable gas/air mixtures in the room where the appliance is located in the event of a leak in the refrigerant circuit. The quantity of refrigerant used in your appliance is indicated on the type plate on the inside of the appliance.
- Do not connect the appliance to the supply with other equipment using an extension cable - risk of overheating.

Connecting to the mains

Power supply (AC) and voltage at the operating point must comply with the details on the type plate, which is located inside the appliance on the left-hand side. The socket must be fused with a 10 A fuse or higher, it must be away from the rear of the appliance and must be easily accessible.

Connect the appliance with a properly earthed fused plug and socket only.

Description of appliance and equipment

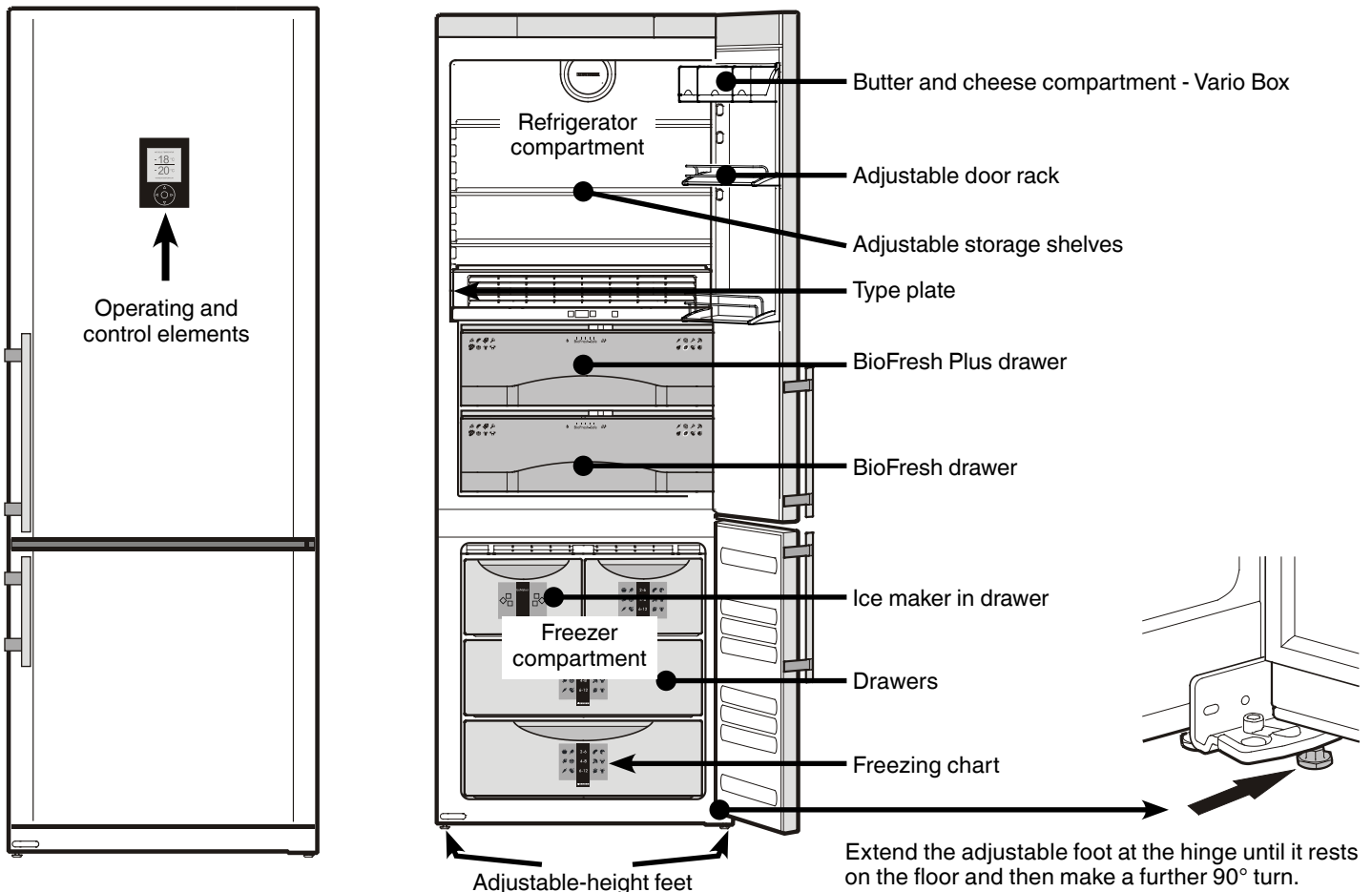

Safety instructions and warnings

- To prevent injury or damage to the unit, the appliance should be unpacked and set up by two people.
- In the event that the appliance is damaged on delivery, contact the supplier immediately before connecting to the mains.
- To guarantee safe operation, ensure that the appliance is set up and connected as described in these operating instructions.
- Disconnect the appliance from the mains if any fault occurs. Pull out the plug, switch off or remove the fuse.
- When disconnecting the appliance, pull on the plug, not on the cable.
- Any repairs and work on the appliance should only be carried out by the customer service department, as unauthorised work could prove highly dangerous for the user. The same applies to changing the mains power cable.
- Do not allow naked flames or ignition sources to enter the appliance. When transporting and cleaning the appliance ensure that the refrigerant circuit is not damaged. In the event of damage, make sure that there are no ignition sources nearby and keep the room well ventilated.
- Do not stand on the plinth, drawers or doors or use them to support anything else.
- This appliance is not intended for use by persons (including children) with reduced physical, sensory or mental capabilities or lack of experience and knowledge unless they have been given initial supervision or instruction concerning use of the appliance by a person responsible for their safety. Children should be supervised to ensure that they do not play with the appliance.
- Avoid prolonged skin contact with cold surfaces or chilled/frozen food. This could cause pain, numbness and frostbite. In the case of prolonged skin contact, protective measures should be taken, e.g. gloves should be worn.
- Do not eat ice cream, particularly ice lollies or ice cubes, immediately after taking them from the freezer compartment as there is a risk of "burning" because of the very cold temperatures.
- Do not consume food which has been stored for too long, as it could cause food poisoning.
- The appliance is designed for cooling, freezing and storage of food, and for making ice and is intended for domestic use. If used for commercial purposes, the relevant legal regulations applicable to the trade concerned must be observed.
- Do not store explosives or sprays using combustible propellants such as butane, propane, pentane etc. in the appliance. Electrical components might cause leaking gas to ignite. You may identify such sprays by the printed contents or a flame symbol.
- Do not use electrical appliances inside the appliance.

Saving energy

- Always ensure good ventilation. Do not cover ventilation openings or grille.
- Always keep fan louvres clear.
- Do not place appliance in areas of direct sunlight or next to a stove, heater or similar object.
- The energy consumption depends on the installation conditions, e.g. the ambient temperature.
- Keep the time the appliance is open to a minimum.
- Store food logically.
- Ensure that all food is well packed and covered for storage. This will prevent frost from forming.
- First cool warm food to room temperature before storing it.
- Defrost frozen food in the refrigerator.
- If there is a thick layer of frost in the appliance: defrost the appliance.
- Empty and switch off refrigerating unit for longer vacation periods.
- Use the vacation function for longer vacation periods.

Accumulated dust increases the energy consumption:

- Once a year, dust the refrigerating unit together with the metal grille of the heat exchanger at the back of the appliance.

Dimensions (mm)

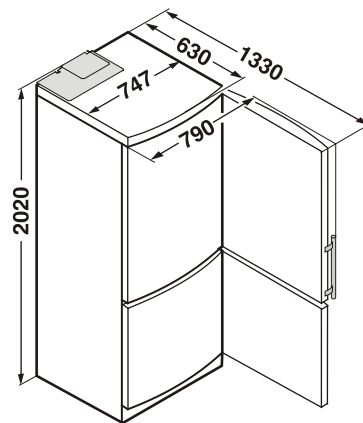

Climate rating

The appliance is set to operate within specific ambient temperature limits according to its climate rating. These temperature limits should not be exceeded. The correct climate rating for your appliance is indicated on the type plate.

Climate rating	Ambient temperature
SN	+10°C to +32°C
N	+16°C to +32°C
ST	+16°C to +38°C
T	+16°C to +43°C

Operating and control elements

- 1 Refrigerator compartment temperature display
- 2 Freezer compartment temperature display
- 3 OK button
- 4 Right button
- 5 Left button
- 6 Up button
- 7 Down button



Switching the appliance on

- Connect the appliance to the mains. The choice of languages will appear in the display.
- Move the cursor down using button ⑦ and up using button ⑥.
- Select the required language and confirm with button ③ = "OK".



Temperature display ① shows the current temperature in the refrigerator compartment.

Temperature display ② (freezer compartment) displays two dashes (- -). A value will only be displayed when the temperature in the freezer compartment reaches 0°C or lower.

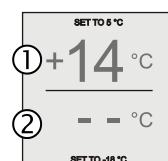

The pre-set temperatures will be displayed above or below the respective temperature display.

The appliance then cools until these temperatures are reached in the refrigerator and freezer compartments.

Activating the main menu:

Press button ③.

Use buttons ⑥ or ⑦ to select one of the menu items:

Note: Press button ⑤ to return to the normal temperature display. If no button is pressed within 60 seconds, the electronic control system switches back automatically.

The main menu contains the following options:

REFRIGERATING

Settings for the refrigerator compartment.

FREEZING

Settings for the freezer compartment.

STORAGE TIMES

Calling up storage times for different kinds of food.

ADDITIONAL FUNCTIONS

Safety and display settings.

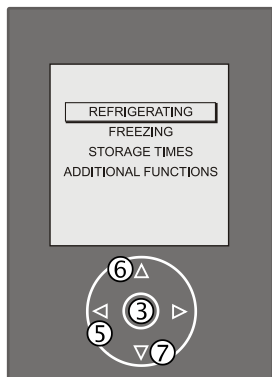

REFRIGERATING in the main menu

Activate the **MAIN MENU**.

Place the cursor on **REFRIGERATING**.

Press button ③ - the menu for **REFRIGERATING**, which contains the following options, will appear in the display.

TEMPERATURE

Temperature settings in the refrigerator compartment.

BIOFRESH PLUS

Temperature settings in the BioFresh Plus drawer.

SUPERCOOL

Activating Supercool.

HOLIDAY

Activating the vacation mode.

ON / OFF

Switching the refrigerator off and on.

Use buttons ⑥ or ⑦ to select one of these items.

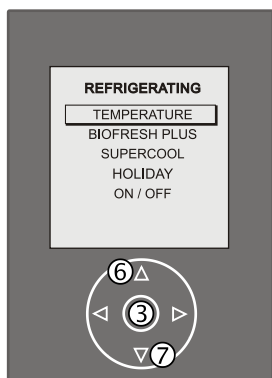

TEMPERATURE

Changing the temperature in the refrigerator compartment

Place the cursor on **TEMPERATURE**. Press button ③.

Information on the recommended refrigerator temperature will be displayed.

Press button ③.

The current temperature is then shown at the top of the display and the desired temperature is shown at the bottom.

Use button ⑦ to reduce the temperature = colder. Use button ⑥ to increase the temperature = warmer (e.g. +8°C).

Press button ③ to accept the new setting or button ⑤ to cancel the procedure without saving.

If the setting is accepted, the refrigerator temperature will be adjusted to +8°C. If the procedure is cancelled, the electronic control system will switch back to the REFRIGERATING menu.

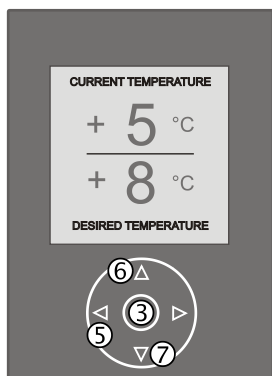

BIOFRESH PLUS

The temperature in the BioFresh Plus drawer can be adjusted depending on the type of food.

0°C for standard storage

6°C for tropical fruits

-2°C for seafood

For detailed information, see section entitled BioFresh.

Setting the temperature in the BioFresh Plus drawer

Activate the **MAIN MENU**.

Activate the **REFRIGERATING** menu.

Place the cursor on **BIOFRESH PLUS**.

Press button ③.

The current temperature is then shown at the top of the display and the desired temperature is shown at the bottom.

Use button ⑦ to reduce the temperature = colder. Use button ⑥ to increase the temperature = warmer.

Press button ③ to accept the new setting or button ⑤ to cancel the procedure without saving.

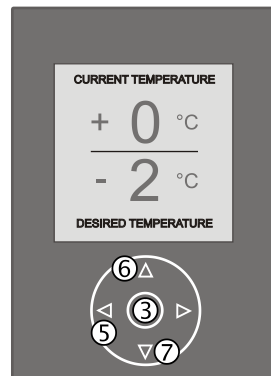

The temperature in the BioFresh Plus drawer can also be adjusted using the control panel above the drawer.

Press the button indicating the desired temperature.

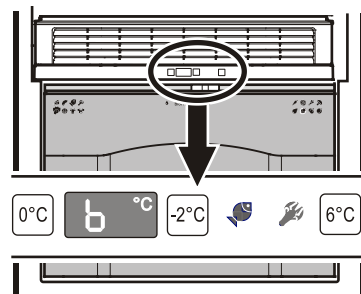

SUPERCOOL

The **SUPERCOOL** function switches the refrigerator compartment to maximum cooling. It is recommended if you wish to cool large quantities of food rapidly.

Activating SUPERCOOL

Activate the **MAIN MENU**.

Activate the **REFRIGERATING** menu.

Place the cursor on **SUPERCOOL**.

Press button ③.

Place the cursor on **INFO**. Press button ③. The information in the display describes what Supercool is used for.

Notes on information messages:

Longer information messages are shown on several pages in the display. Use button ④ to go forward to the next page or button ⑤ to go back to the previous page.

Press button ⑤ until ON and INFO are displayed again.

Place the cursor on **ON**.

Press button ③. Supercool is activated.

Supercool is deactivated automatically after 6 hours.

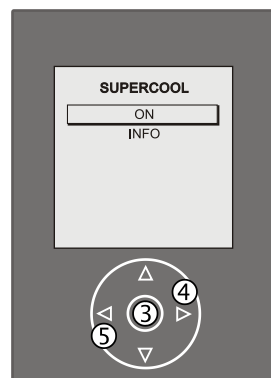

Prematurely deactivating Supercool:

Activate the **MAIN MENU**.

Activate the **REFRIGERATING** menu.

Activate the **SUPERCOOL** menu.

Place the cursor on **OFF**.

Press button ③. Supercool is deactivated.

HOLIDAY - VACATION MODE

In the case of lengthy periods of absence, the **refrigerator** can be switched to an individual operating mode. After removing the food, the vacation mode can be activated. Due to the constant temperature in the refrigerator, the build-up of odours will be avoided, even if the appliance door remains closed.

Activating the VACATION mode

Activate the **MAIN MENU**.

Activate the **REFRIGERATING** menu.

Place the cursor on **HOLIDAY**.

Press button ③.

Place the cursor on **INFO**. Press button ③. The information in the display describes what the vacation mode is used for.

Press button ⑤ until ON and INFO are displayed again.

Place the cursor on **ON**.

Press button ③.

The vacation mode is activated.

The word **HOLIDAY** will appear at the top of the display.

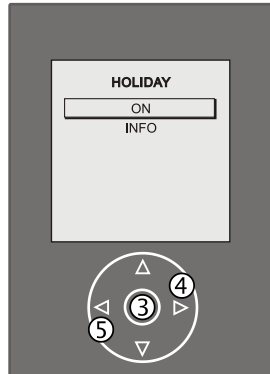

Deactivating the vacation mode:

Activate the **MAIN MENU**.

Activate the **REFRIGERATING** menu.

Activate the **HOLIDAY** menu.

Place the cursor on **OFF**.

Press button ③. The vacation mode is deactivated.

ON / OFF

Switching the refrigerator off and on

Activate the **MAIN MENU**.

Activate the **REFRIGERATING** menu.

Place the cursor on **ON / OFF**.

Press button ③.

Place the cursor on **INFO**. Press button ③. The information in the display describes how to switch the refrigerator compartment on/off.

Press button ⑤ until OFF and INFO are displayed again.

Place the cursor on **OFF**.

Press button ③. The refrigerator compartment is switched off.

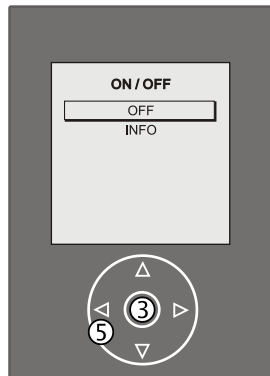

Note: If the refrigerator compartment is to be switched off for a long time, then the vacation mode should be activated after all food has been removed.

If the refrigerator is switched off, the interior should be cleaned and the door should be left open slightly to avoid the build-up of odours.

Switching the refrigerator on again:

Activate the **MAIN MENU**.

Activate the **REFRIGERATING** menu.

Activate the **ON / OFF** menu.

Place the cursor on **ON**.

Press button ③. The refrigerator compartment is operational again.

FREEZING in the main menu

Activate the **MAIN MENU**.

Place the cursor on **FREEZING**.

Press button ③ - the menu for **FREEZING**, which contains the following options, will appear in the display.

TEMPERATURE

Temperature settings in the freezer compartment.

SUPERFROST

Activating Superfrost.

ICEMAKER

Switching the ice maker on and off.

ON / OFF

Switching the freezer off and on.

Use buttons ⑥ or ⑦ to select one of these items.

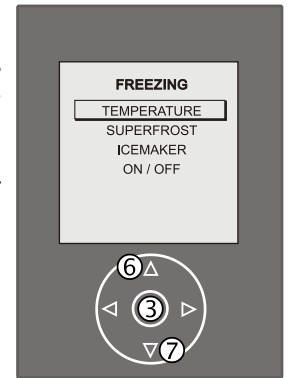

TEMPERATURE

Changing the temperature in the freezer compartment

Place the cursor on **TEMPERATURE**.

Press button ③.

Information on the recommended freezer temperature will be displayed.

Press button ③.

The current temperature is then shown at the top of the display and the desired temperature is shown at the bottom.

Use button ⑥ to increase the temperature = warmer. Use button ⑦ to reduce the temperature = colder (e.g. -20°C).

Press button ③ to accept the new setting or button ⑤ to cancel the procedure without saving.

If the setting is accepted, the freezer temperature will be adjusted to -20°C. If the procedure is cancelled, the electronic control system will switch back to the FREEZING menu.

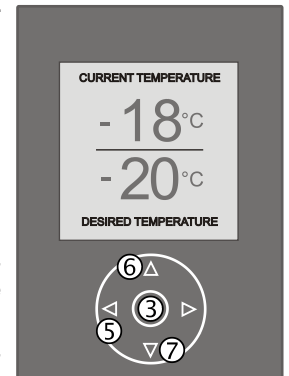

SUPERFROST

Fresh food should be frozen to the core as rapidly as possible. This is provided by the Superfrost facility.

The maximum amount of food (in kg) which can be frozen in 24 hours is shown on the type plate ("Freezing capacity").

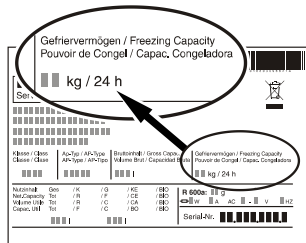

Activating Superfrost

Activate the **MAIN MENU**.

Activate the **FREEZING** menu.

Place the cursor on **SUPERFROST**. Press button ③.

Place the cursor on **INFO**. Press button ③. The information in the display describes what Superfrost is used for.

Press button ⑤ until ON and INFO are displayed again.

Place the cursor on **ON**.

Press button ③. Superfrost is activated.

- For small amounts of frozen food, it is normally sufficient to switch on Superfrost 6 hours beforehand. For the maximum amount (see freezing capacity on the type plate) you will need to switch it on 24 hours beforehand.
- Then place the fresh food inside the freezer.
- The Superfrost function switches off **automatically**. Depending on the quantity of food placed in the freezer, this will normally be between 30 and max. 65 hours.

Prematurely deactivating Superfrost:

Activate the **MAIN MENU**.

Activate the **FREEZING** menu.

Activate the **SUPERFROST** menu.

Place the cursor on **OFF**.

Press button ③.

Superfrost is deactivated.

You should not switch on the Superfrost function:

- when placing frozen food in the freezer;
- when freezing up to 2 kg fresh food daily.

Notes on freezing

- Pack food which you are freezing yourself in quantities appropriate to your household. To ensure that the food freezes right through, the following quantities should not be exceeded per package: fruit, vegetables: up to 1 kg, meat: up to 2.5 kg.
- Do not allow fresh food which is to be frozen to come into contact with food already frozen. Always keep packs dry in order to avoid them sticking together.
- Always write the date and contents on the pack and do not exceed the stated storage time for the food.
- Do not freeze bottles and cans which contain carbonated drinks as they might burst.
- Only take out as much food as is immediately required for thawing. Use food which has been thawed in prepared meals as quickly as possible.

Frozen food can be thawed in the following ways: in a fan oven, in a microwave oven, at room temperature, in the refrigerator.

ICEMAKER

Activating the ice maker

Activate the **MAIN MENU**.

Activate the **FREEZING** menu.

Place the cursor on **ICEMAKER**. Press button ③.

ON/OFF will appear in the display. Press button ③.

Place the cursor on **INFO**. Press button ③. The information in the display describes what you should note when using the ice maker.

!!! Before the ice maker is switched on, ensure that the water supply has already been connected to the appliance. Information about this can be found in the separately enclosed icr maker operating instructions. If the water supply has been connected, the ice maker can be activated.

Press button ⑤ until ON and INFO are displayed again.

Place the cursor on **ON**. Press button ③.

The ice maker is now switched on. A symbol will appear in the display to show that ice cubes are being produced.

When the ice cube drawer is full, a new symbol is shown in the display.

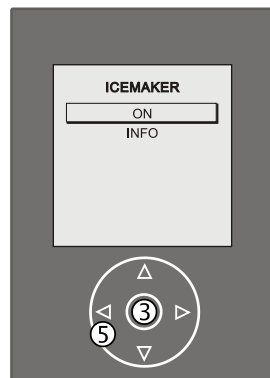

Switching off the ice maker:

Activate the **MAIN MENU**.

Activate the **FREEZING** menu.

Activate the **ICEMAKER** menu.

Place the cursor on **ON/OFF**. Press button ③.

Place the cursor on **OFF**. Press button ③.

The ice maker is switched off.

ICE CUBE SIZE

The ice cube size can be changed by adjusting the water intake time.

Activate the **MAIN MENU**.

Activate the **FREEZING** menu.

Place the cursor on **ICEMAKER**. Press button ③.

Place the cursor on **ICE CUBE SIZE**.

Press button ③.

The current setting is then shown at the top of the display and the new setting is shown at the bottom. The standard setting is **E 5**.

Press button ⑦ to increase the water intake time (E 6 - E 8). The ice cubes will be larger.

Press button ⑥ to reduce the water intake time (E 4 - E 1). The ice cubes will be smaller.

Press button ③ to accept the new setting or button ⑤ to cancel the procedure without saving.

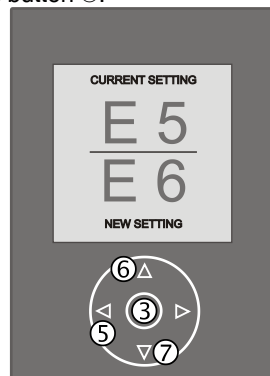

Important

The water intake time must not be too long. The ice cube tray in the ice maker may overflow.

TWISTCLEAN

The TWISTCLEAN function is used for cleaning the ice maker. For detailed information, see section entitled **Cleaning**.

ON / OFF

Switching the freezer off and on

Activate the **MAIN MENU**.
Activate the **FREEZING** menu.

Place the cursor on **ON / OFF**.
Press button ③.

Place the cursor on **INFO**. Press button ③. The information in the display describes how to switch the freezer compartment on/off.

Press button ⑤ until OFF and INFO are displayed again.

Place the cursor on **OFF**.
Press button ③. The freezer compartment is switched off.

Note: If the freezer is switched off for a long time, the interior should be cleaned and the door should be left open slightly to avoid the build-up of odours.

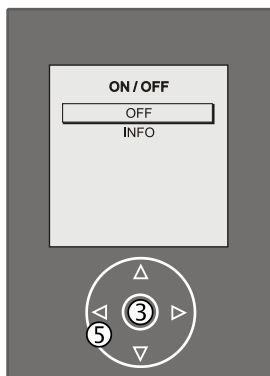

Switching the freezer on again:

Activate the **MAIN MENU**.
Activate the **FREEZING** menu.
Activate the **ON / OFF** menu.

Place the cursor on **ON**.
Press button ③. The freezer compartment is operational again.

STORAGE TIMES in the main menu

Activate the **MAIN MENU**.
Place the cursor on **STORAGE TIMES**. Press button ③.

Information on the recommended storage times for food will be displayed. Press button ③ to switch directly to the Storage times menu. After approx. 30 seconds, the electronic control system will switch over automatically to this menu.

The names of different kinds of food will be displayed.

Use buttons ⑥ or ⑦ to select one of these items (e.g. FISH).

Press button ③.

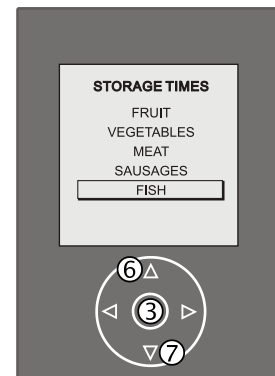

A table will appear in the display with the letters A to Z. These stand for the first letter of the food you are looking for.

The cursor can be moved around the table in all directions using the arrow keys.

Choose the required letter (e.g. **"S"**) and press button ③.



A list of food designations will appear in the display. The cursor is on the first kind of food which begins with the letter **"S"** (e.g. **SALMON**).

Note: If the selected letter is not available in the list, the cursor will highlight the word beginning with the next letter.

Press button ③.

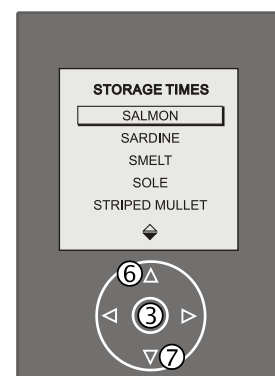

The recommended storage times for **SALMON** are shown in the display.

The storage times depend on where the food is stored.

REFRIGERATING BIOFRESH FREEZING

Press button ⑤ to return to the food groups and choose a new group. To return to the temperature display, press any other button.

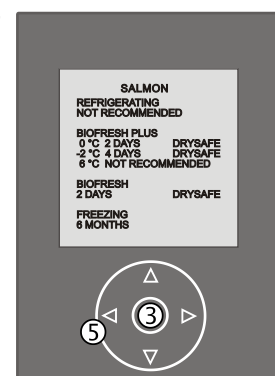

ADDITIONAL FUNCTIONS in the main menu

Activate the **MAIN MENU**.

Place the cursor on **ADDITIONAL FUNCTIONS**.

Press button ③ - the menu for **ADDITIONAL FUNCTIONS**, which contains the following options, will appear in the display.

CHILD PROOFING

Protection against appliance being switched off accidentally or temperature being changed.

BIOFRESH

Correcting the temperature in the BioFresh drawer.

BIOFRESH PLUS

Correcting the temperature in the BioFresh Plus drawer.

NET@HOME

Activating an interface (available as an accessory).

CONFIGURATION

Display settings.

Use buttons ⑥ or ⑦ to select one of these items.

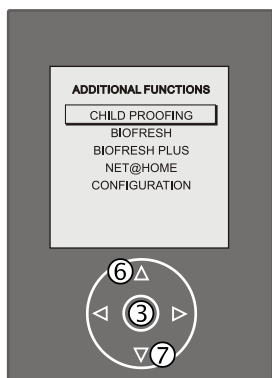

CHILD PROOFING

Activating the child lock

Place the cursor on **CHILD PROOFING**.

Press button ③.

Place the cursor on **INFO**.

Press button ③.

The information in the display describes the purpose of the child lock.

Press button ⑤ until **ON** and **INFO** are displayed again.

Place the cursor on **ON**.

Press button ③.

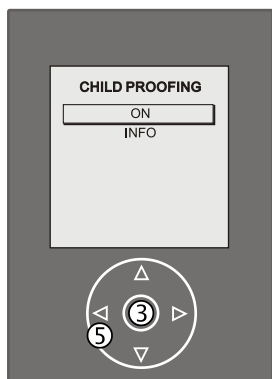

The child lock is activated. The symbol for **CHILD PROOFING ON** will appear in the display. The settings cannot be changed.

When any button is pressed, an information message will appear which describes the first step to be taken in order to deactivate the child lock.

Deactivating the child lock:

Press button ③ for 3 seconds - the **main menu** will be activated.

Activate the **ADDITIONAL FUNCTIONS** menu.

Activate the **CHILD PROOFING** menu.

Place the cursor on **OFF**.

Press button ③.

The child lock is deactivated.

BIOFRESH

The temperature of both BioFresh drawers can easily be adjusted if required.

Activate the **MAIN MENU**.

Activate the **ADDITIONAL FUNCTIONS** menu.

Place the cursor on **BIOFRESH**.

Press button ③.

Place the cursor on **INFO**. Press button ③.

The information in the display indicates the BioFresh adjustment range.

Press button ⑤ until **SETTING** and **INFO** are displayed again.

Place the cursor on **SETTING**. Press button ③.

The current setting is then shown at the top of the display and the new setting is shown at the bottom.

Use button ⑥ to increase the temperature = warmer (B 6 - B 9). Use button ⑦ to reduce the temperature = colder (B 4 - B 1).

Press button ③ to accept the new setting or button ⑤ to cancel the procedure without saving.

Note: At very low settings (B 4 - B 1), minus temperatures can be reached. Take care with cold-sensitive food.

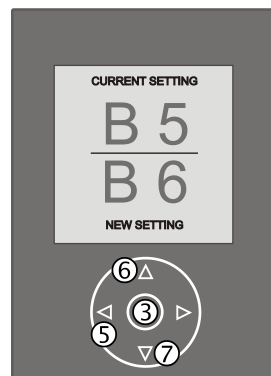

BIOFRESH PLUS

Setting as for menu item **BIOFRESH**. The setting range is from U 1 - U 9.

NET@HOME

The appliance can be retrofitted with modules for the HomeDialog system or the serial interface (RS 232). The modules are available from your specialist dealer.

More information can be found at www.liebherr.com

CONFIGURATION

In the Configuration menu it is possible to change the display settings.

Activate the **MAIN MENU**.

Activate the **ADDITIONAL FUNCTIONS** menu.

Place the cursor on **CONFIGURATION**. Press button ③ - the **CONFIGURATION** menu, which contains the following options, will appear in the display.

LIGHTING

Setting the display brightness.

CONTRAST

Setting the display contrast.

LANGUAGE

Setting the language in which the menus are to be shown.

Use buttons ⑥ or ⑦ to select one of these items.

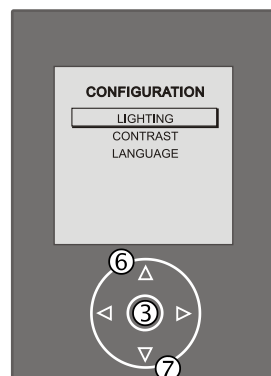

LIGHTING

Setting the display brightness

Activate the **MAIN MENU**.

Activate the **ADDITIONAL FUNCTIONS** menu.

Activate the **CONFIGURATION** menu.

Place the cursor on **LIGHTING**. Press button ③.

Place the cursor on **SETTING**. Press button ③.

Use buttons ⑥ or ⑦ to set the brightness between level 1 and 5.

1 = display dark
5 = display bright

Press button ③.

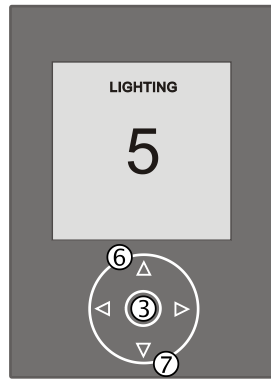

CONTRAST

In this option, the contrast between the writing and background can be adjusted.

Activate the **MAIN MENU**.

Activate the **ADDITIONAL FUNCTIONS** menu.

Activate the **CONFIGURATION** menu.

Place the cursor on **CONTRAST**. Press button ③.

Place the cursor on **SETTING**. Press button ③.

Use buttons ⑥ and ⑦ to set the contrast between level 1 and 10.

1 = low contrast
10 = high contrast

Press button ③.

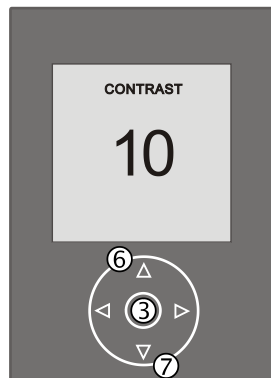

LANGUAGE

Setting the language

Activate the **MAIN MENU**.

Activate the **ADDITIONAL FUNCTIONS** menu.

Activate the **CONFIGURATION** menu.

Place the cursor on **LANGUAGE**.

Press button ③.

The choice of languages will appear in the display.

Use buttons ⑥ or ⑦ to select the desired language.

Press button ③.

All menus will now appear in the set language.



ALARM FUNCTIONS

The electronic control system is equipped with alarm functions, which are activated if excessive temperatures or malfunctions occur.

Alarm > Freezer temperature too high

If the temperature in the freezer is too high, this will be shown in the display and the audible warning signal will sound.

Press button ③ to cancel the alarm. The display will switch back to the temperature display.

The relative alarm is shown in the display:

> **Temperature too high**
> **Power failure**

This can be caused by:

- the appliance door being left open for a long time, allowing warm ambient air to enter;
- a long power failure;
- a fault in the appliance.

In each case, make sure food has not thawed or perished. If the alarm state lasts, contact the customer service department (see section on Malfunctions).



Alarm > Appliance door open

If an appliance door is left open for more than 60 seconds, the message **PLEASE CLOSE THE DOOR** will be shown in the display (for REFRIGERATOR or FREEZER respectively). The audible warning signal sounds.

Press button ③ to cancel the alarm.

If the door is closed, the normal temperature display appears in the display.



Alarm > Icemaker

If a malfunction occurs in the ice maker, the respective alarm is shown in the display.

> **CHECK THE WATER SUPPLY**

> **ICE CUBE TRAY CANNOT BE EMPTIED**

> **SENSOR FAULT**

> **MECHANICAL FAULT**

The audible warning signal sounds.

Press button ③ to cancel the alarm. The display switches back to the temperature display. **ICEMAKER FAULT** is shown in the display.

Check whether there is an operating error (see section on **Malfunctions** in the separately enclosed Ice maker operating instructions). If you are unable to rectify the fault yourself, contact your customer service department.

Alarm > F1 to F5

If F1 to F5 appears in the display, the appliance has a fault. In this case, contact the customer service department (see section on Malfunctions).

BioFresh compartment

The BioFresh compartment enables you to keep food for up to 3 times longer than in normal refrigerators.

The constant temperature of just above 0°C and the adjustable humidity provide the ideal storage conditions for different types of food.

Humidity selection:

- **dry:** small humidity symbol - slide control to left. This setting is suitable for dry or wrapped food like dairy products, meat, fish, cold meats.
- **moist:** high relative humidity of max. 90%, large humidity symbol - slide control to right. This setting is suitable for storing unwrapped food with a high moisture content such as salad, vegetables and fruit.

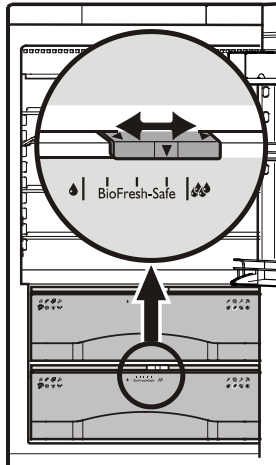

Notes

- Unwrapped animal and vegetable foods should be stored separately in the drawers. If there is not enough space for them to be stored separately, make sure that they are wrapped. Do not allow different types of meat to come into contact with one another but keep them packaged separately so as to avoid premature bacterial spoilage.
- The following products should not be stored in the BioFresh compartment: potatoes, cold-sensitive vegetables such as cucumber, aubergines, avocados, semi-ripe tomatoes, zucchini, and all cold-sensitive tropical fruits such as pineapple, bananas, grapefruit, melons, mangoes, papaya, etc.

BioFresh Plus drawer

The top drawer in the BioFresh compartment has extended temperature settings. If the temperature is set to 0°C, the same conditions can be found as in the lower BioFresh drawer.

The temperature for the top BioFresh drawer is set via the control panel above it.

Press the button indicating the desired temperature.

Storage of tropical fruits at 6°C.

Storage of seafood at -2°C.

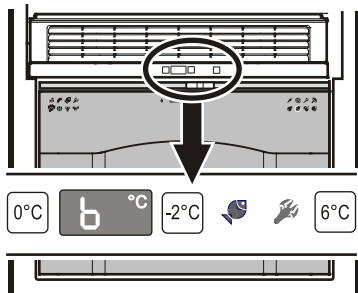

Removing the BioFresh drawers

Pull the drawer out as far as it will go, lift slightly at the back and remove.

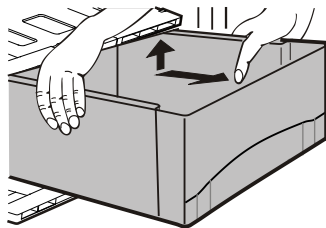

Inserting the BioFresh drawers

Extend the pull-out rails as far as they will go. Place the drawer on the rails and slide it right in.

Equipment

You can re-arrange the **storage shelves** as required.

Lift the glass shelf, align the recess over the support and replace the shelf in a higher or lower position.

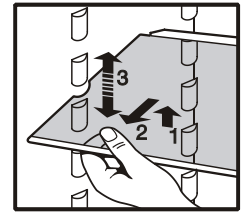

Repositioning the door racks

- Lift door rack vertically (1), lift out to the front and re-insert at a different height, following these steps in the reverse order (2).
- By shifting the **bottle holder F** you can protect the bottles from falling over when opening or closing the door.

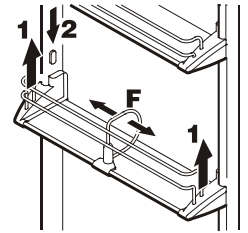

The boxes can be removed and placed on the table as a single unit.

- Re-positioning the boxes: Lift them for removal and re-position them as required.

The box support bar can be removed by lifting upwards and inserted in another position (e.g. swapped with a door rack).

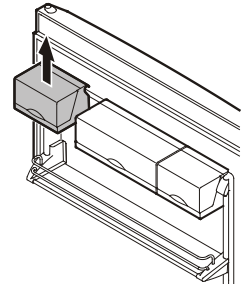

Important! Box lids must be shut when you close the door - risk of damage.

- To detach the lid: open 90° and raise to disengage.

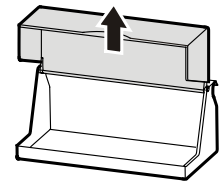

The sectioned glass shelves

can be moved to make space for tall containers. Place the shelf rails provided, fig. 1, on the supports on the left and right at the desired height.

Insert the glass shelves ① and ② as shown in fig. 2. The glass shelf ② with the raised edge must go at the back.

If you need to make space for tall containers, simply slide the **front half** of the sectioned glass shelf carefully underneath the back half, fig. 2.

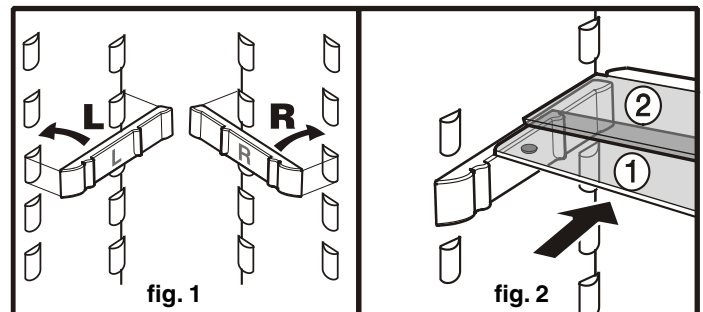

Interior light

There is an interior light on the right and left of the refrigerator compartment and on the left next to the BioFresh drawers. The light comes on when the refrigerator door is opened.

In addition, a strip light is attached to the underside of the refrigerator door. This comes on when the freezer door is opened to light up the freezer compartment.

Caution - class 1M laser radiation. When cover is removed, do not look directly at light through optical instruments. Severe eye injury can occur.

The light switches off when one of the doors has been left open for more than 15 minutes. At the same time, the audible warning signal sounds.

If one of the strip lights is not lit, it is defective.

The lighting may only be replaced by the customer service technician or by competent skilled personnel!

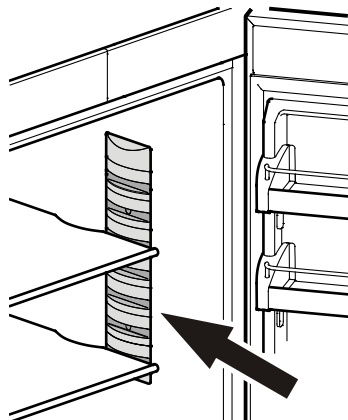

Freezing chart

The freezing chart represents the frozen food and the time it can be safely stored in months.

The individual storage times and whether or not the lower or upper value is applicable depend on the food quality, its processing prior to freezing, and the individual household's quality requirements. The lower values always apply to food with a high fat content.

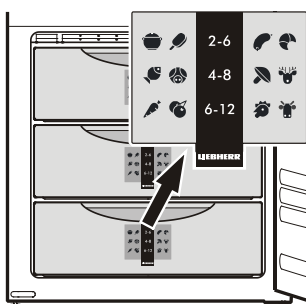

Cold-storage accumulators

The cold-storage accumulators provided prevent the temperature in the freezer from rising too quickly in the event of a power failure, thus preserving the quality of the food.

To ensure maximum storage time in the event of a power failure, place the cold-storage accumulators in the top-most freezer drawer on top of the food.

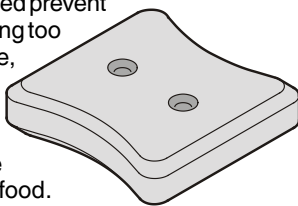

Defrosting

Refrigerator compartment

The refrigerator compartment defrosts automatically. The water that forms on the rear wall drains into a reservoir at the back of the appliance and evaporates automatically through the compressor heat.

Freezer compartment

The NoFrost system automatically defrosts the appliance.

Any moisture arising collects on the evaporator and freezes, and is periodically defrosted and evaporated.

Cleaning

Before cleaning always switch off the appliance. Pull out the mains plug or switch off or unscrew the fuse.

- First clean the side panels with a conventional stainless steel cleaner. Subsequently, apply the enclosed stainless steel care product evenly onto the surfaces in the same direction in which they have been ground or polished.
- Only clean the door surfaces with a clean and soft cloth. If necessary, moisten the cloth (water + detergent). Alternatively, use a micro-fibre cloth.
- Do not use abrasive sponges or scourers, do not use concentrated cleaning agents and never use cleaning agents containing sand, chloride or acid or chemical solvents, as these would damage the surfaces and could cause corrosion.
- Clean the inside and equipment with lukewarm water and a little detergent.

Do not use steam cleaners because of the risk of injury and damage.

- Ensure that no cleaning water penetrates into the electrical components or ventilation grille.
- Dry all parts well with a cloth.
- Clean the drain hole in the refrigerator compartment with a thin object, e.g. cotton swab or the like.
- Do not damage or remove the type plate on the inside of the appliance. It is very important for servicing purposes.

Cleaning the ice maker

The ice cube drawer has to be empty and slid into place.

Activate the **MAIN MENU**.

Activate the **FREEZING - ICEMAKER - TWISTCLEAN** menu items one after the other.

Set the cursor to **INFO**. Press button ③.

The information in the display describes the use of the TwistClean function.

Press button ⑤ until **START** and **INFO** are displayed again.

Place the cursor on **START**. Press button ③.

TWISTCLEAN appears in the display at the bottom, the ice maker moves into cleaning position.

When **TWISTCLEAN** goes out in the display: Remove the ice cube drawer and clean with warm water and a little washing-up liquid.

Slide the ice cube drawer back into place.

Either leave the ice maker switched off in this position or switch it on again via **MAIN MENU - FREEZING - ICEMAKER - ON**.

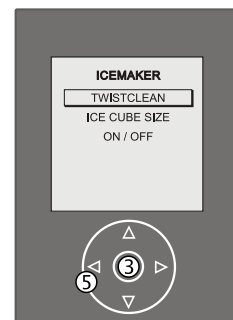

- 10. Transfer fastener for soft stop mechanism to the opposite side.
- 11. Transfer cover plate to the opposite side.

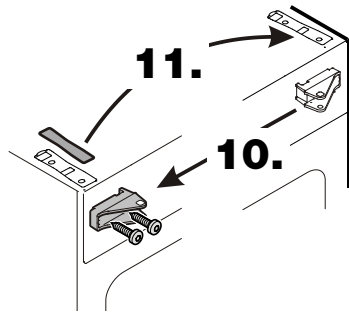

Centre right of appliance

- 18. Pull out middle hinge pin.
- 19. Remove bottom door.

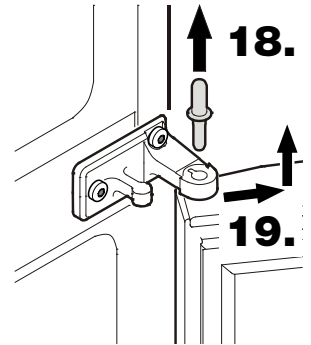

Bottom right

- 12. Remove cover.

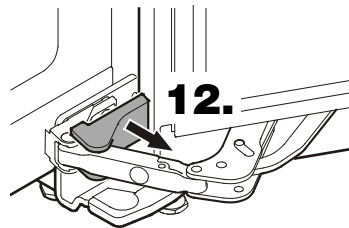

Centre of appliance

- 20. Unscrew hinge bracket.
- 21. Transfer cover plate to the opposite side.
- 22. Turn hinge bracket through 180° and screw into place.

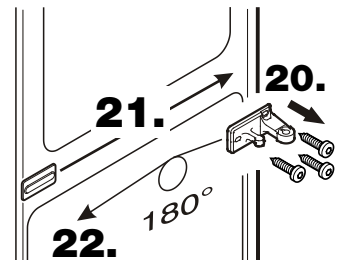

- 13. Open bottom door, prise off door cover.

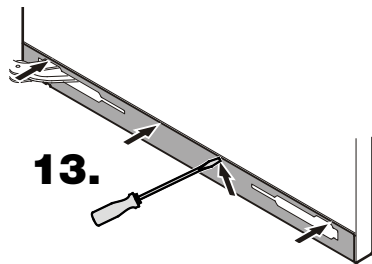

Centre left of appliance

- 23. Remove hinge bushing, turn through 180° and re-fit.

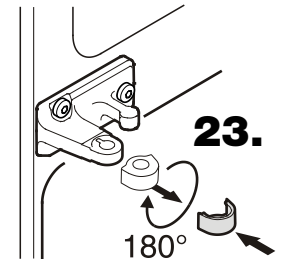

Bottom right

- 14. Pivot door cover to the left.
- 15. Slide red safety bracket over the hinge.
- 16. Remove pin.

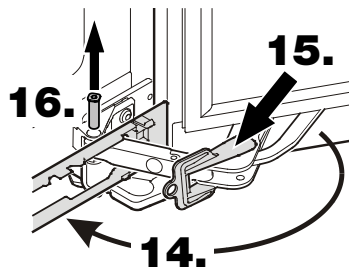

Bottom right

- 24. Remove covers.
- 25. Remove spacer.
- 26. Tilt appliance slightly backwards and pull out hinge pin.
- 27. Unscrew hinge bracket.

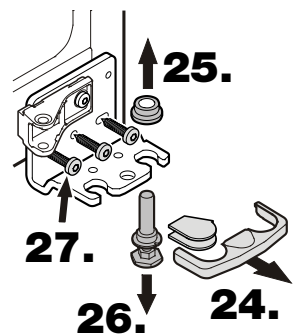

- 17. Open bottom door wide and remove cover.

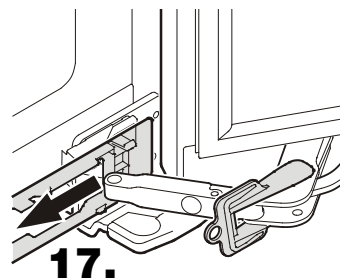

- 28. Transfer fastener for soft stop mechanism on hinge bracket to the opposite side.

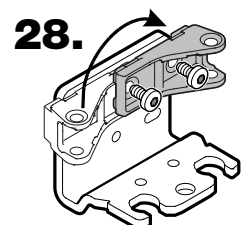

Bottom of appliance

- 29. Transfer cover plate to the opposite side.
- 30. Screw hinge bracket into place.

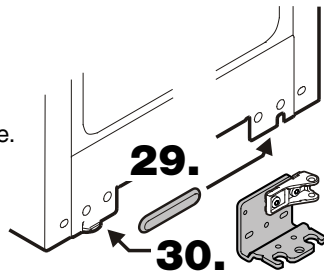

Bottom left

- 31. Tilt appliance slightly backwards, insert hinge pin and fit spacer.
- 32. Click covers into place.

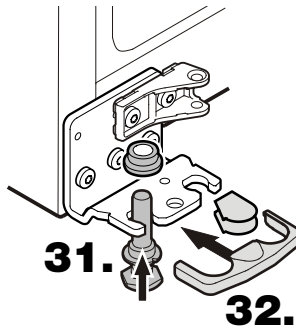

Both doors

- 33. Lever out pressure plates at the front and slide away.
- 34. Transfer door handles and plugs to the other side.

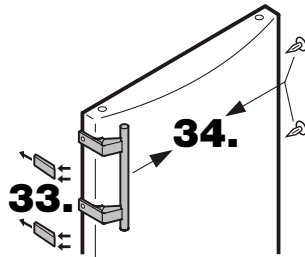

- 35. Transfer panels of both door covers to the opposite side.

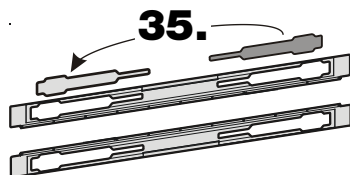

Both doors

- 36. Remove screw.
- 37. Pivot soft stop mechanism outwards on the right, pull to the right and remove.
- 38. Slide spacer to the left and remove.

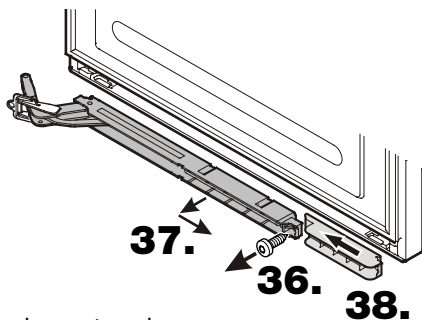

Both doors

- 39. Turn spacer through 180° and re-fit on the opposite side.
- 40. Turn soft stop mechanism through 180° and re-fit on the opposite side. Then secure both parts with screws.

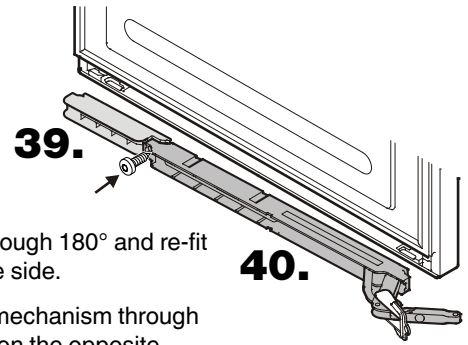

Bottom left

- 41. Suspend bottom door on hinge pin.

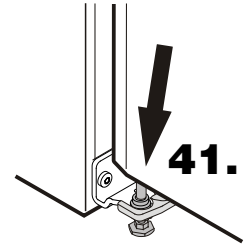

Centre left of appliance

- 42. Insert middle hinge pin.

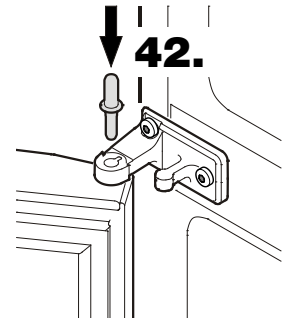

Bottom left

- 43. Slide door cover over soft stop mechanism hinge.

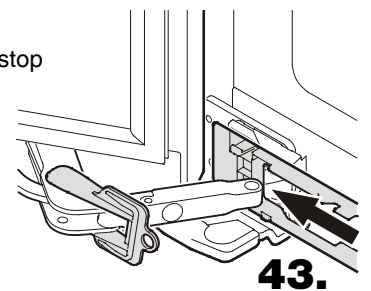

Bottom left

- 44. Move soft stop mechanism hinge to the fastener and insert pin.
- 45. Remove red safety bracket.
- 46. Pivot door cover to the left and click into place on the door.

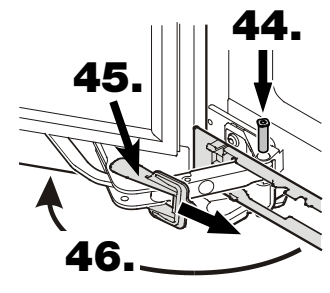

Bottom left

47. Click cover into place.

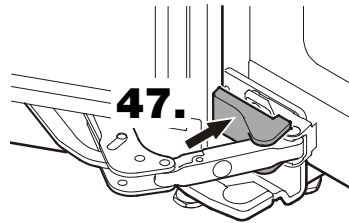

Top left

54. Secure door with screws and click cover into place.

55. Plug in the connector and insert the cable in the guide.

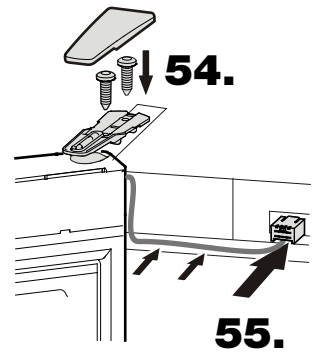

Refrigerator door

48. Disconnect the connector.

49. Using a screwdriver, push out the hinge from underneath and remove it from the door complete with the cable.

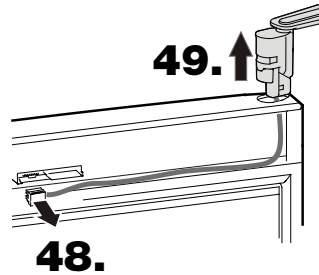

Top left

56. Click cover into place.

57. Slide door cover over soft stop mechanism hinge.

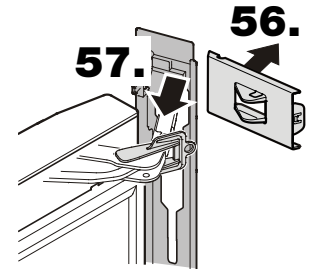

Refrigerator door

50. Using a screwdriver, push out the plug from underneath and transfer it to the opposite side.

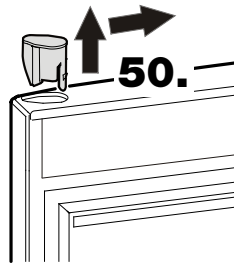

Top left

58. Pull the right-hand side of the cover approx. 5 mm towards you.

59. Move soft stop mechanism hinge to the fastener and insert pin.

60. Remove red safety bracket.

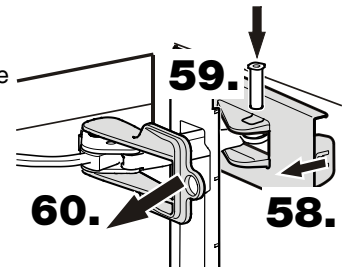

Refrigerator door

51. Feed in the cable of the hinge at the opposite side and insert hinge.

52. Plug in the connector. Place the cable in the guide.

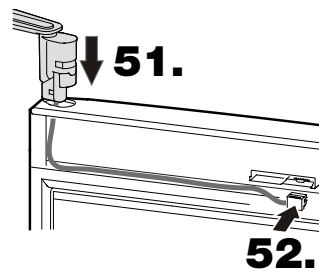

Top left

61. Pivot door cover to the left and click into place on the door.

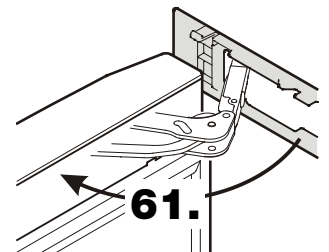

Centre left of appliance

53. Suspend top door on hinge pin. For this, the door must be open at least 90°.

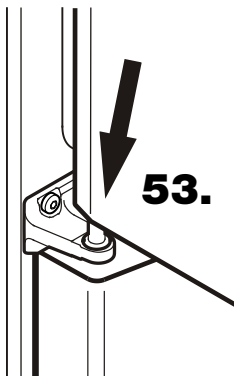

Top right

62. Click covers into place.

